



MORE[®] | 茂昌电子
CHANCE

CUSTOMER : STD
PRODUCTS : Molding Typ SMD Power Inductor
PART NO : MCSM2/3/4 Series
CUST P/ NO :
DATE : 2023.04.14
SALES DEP :
E-MAIL :

VERSION : REV.A
CHANGE PROJECT :
BEFORE : -
AFTER : -
CHANGE DATE : -
CUSTOMER SIGNATURE : -

APPROVAL BY :	CHECK BY :	DRAWN BY :
<i>Honey Wei</i>	<i>Leo Wang</i>	<i>May Gao</i>



MORE[®]
CHANCE

茂昌电子

Suzhou, Wuzhong District, Taihu East Road No.9, Wuluo science and Technology Park, 4th floor, 401/408 Room

TEL : 0512-6856-2977
TEL : 0755-2738-9457

Specifications subject to change without notice. Please confirm according to our company for latest information.

MCSM2/3/4 Series

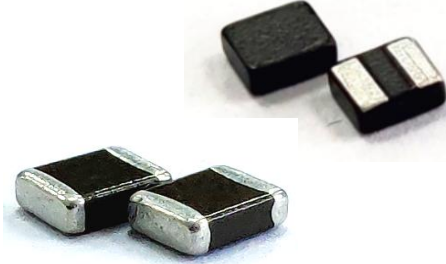

- SHIELDED SMD POWER INDUCTOR
- Operating Temperature up to $-40\text{ }^{\circ}\text{C} \sim 125\text{ }^{\circ}\text{C}$
- High Current up to 20 A
- Low DCR down to 8.0mOhms
- Environmental Lead free
- Environmental RoHS2.0 compliant
- Environmental halogen free
- Storage Temperature : $+5\text{ }^{\circ}\text{C} \sim +40\text{ }^{\circ}\text{C}$
- Packaging 7"~13"Reel ,Plastic tape: 8.0~12.0mm wide

FEATURES

- High magnetic flux saturation density characteristics by metal magnetic material.
- Low DC resistance by flat wire and achieve high conversion efficiency and lower temperature rising.
- High mounting stability due to Chip shape.
- High reliability by original structure.
- Magnetically shielded structure to accomplish high resolution in EMC protection.

Applications

- Smartphones, Tablets and Wearable Devices.
- HDD,SSD, and PC Peripheral Devices.
- Camcorders.
- PND.
- DC/DC converters.

PRODUCT IDENTIFICATION

MC SM 201610A Z R10 M B
 ① ② ③ ④ ⑤ ⑥ ⑦

- ① Brand & Product classification
- ② Product Series NO.(SM : Molding Typ SMD Power Inductor.)
- ③ External Dimensions.(201610 : L:2.0 × W:1.6 × H:1.0) [mm] (A : A Typ)
- ④ Separator code.
- ⑤ Nominal Inductance

Example	Nominal Value
R22	0.22uH
1R0	1.0uH
100	10uH

- ⑥ Inductance Tolerance.(L: $\pm 15\%$; M: $\pm 20\%$; N: $\pm 30\%$)
- ⑦ Material Code.(B : B Typ , C : C Typ , G : G Typ , T : T Typ)

Mechanical & Dimensions (Unit: mm)

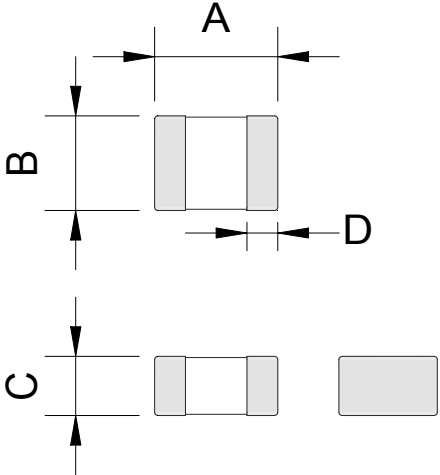
	Code	Dimensions
	A	2.0±0.25
	B	1.6±0.25
	C	1.0 Max
	D	0.5±0.3

Recommend Land Pattern Dimensions (Unit: mm)

	Code	Dimensions
	a	1.8 Ref
	b	2.4 Ref
	c	0.8 Ref

Electrical Characteristics

Part Number	Inductance ¹ (μH)	DCR ² (mΩ) Max	I-sat ³ (Amps)Typ	I-rms ⁴ (Amps)Typ		
MCSM201610AZR47MB	0.47±20%	38.0 Max	5.5	4.0		
MCSM201610AZ1R0MB	1.0±20%	78.0 Max	4.0	2.5		
MCSM201610AZ1R5MB	1.5±20%	99.0 Max	3.1	2.3		
MCSM201610AZ2R2MB	2.2±20%	144.0 Max	2.3	2.0		

Note:

- Inductance is measured at 1.0 MHz and 0.25 Vrms at 25°C
- The nominal DCR is measured at 20°C ambient temperature.
- The I-sat that will cause initial inductance value approximately 70% rolloff ,or secure 65% of the nominal L value at 25°C
- The I-rms that will cause temperature rise approximate 40°C without core loss.

※ Withstand DC Voltage : 20.0V Max
 ※ Operating Voltage : 16.0V Max

Mechanical & Dimensions

(Unit: mm)

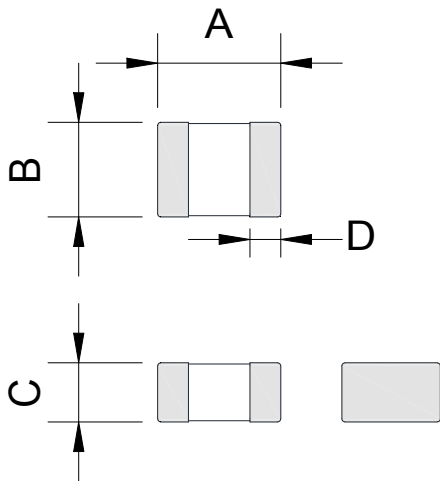

Code	Dimensions
A	2.5±0.25
B	2.0±0.25
C	1.0 Max
D	0.6±0.3

Recommend Land Pattern Dimensions

(Unit: mm)

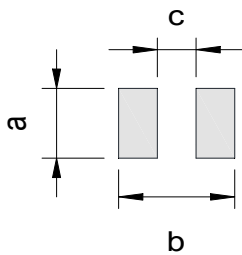

Code	Dimensions
a	2.0 Ref
b	2.8 Ref
c	1.2 Ref

Electrical Characteristics

Part Number	Inductance ¹ (μ H)	DCR ² (m Ω) Max	I-sat ³ (Amps)Typ	I-rms ⁴ (Amps)Typ		
MCSM252010AZ1R0MC	1.0±20%	78.0 Max	3.4	3.0		
MCSM252010AZ1R5MC	1.5±20%	108 Max	2.7	2.3		
MCSM252010AZ2R2MC	2.2±20%	156 Max	2.4	1.8		
MCSM252010AZ3R3MC	3.3±20%	228 Max	1.9	1.4		
MCSM252010AZ4R7MC	4.7±20%	300 Max	1.6	1.2		

Note:

- Inductance is measured at 1.0 MHz and 0.5 Vrms at 25°C
- The nominal DCR is measured at 20°C ambient temperature.
- The I-sat that will cause initial inductance value approximately 70% rolloff ,or secure 65% of the nominal L value at 25°C
- The I-rms that will cause temperature rise approximate 40°C without core loss.

※ Withstand DC Voltage : 20.0V Max
 ※ Operating Voltage : 16.0V Max

Mechanical & Dimensions

(Unit: mm)

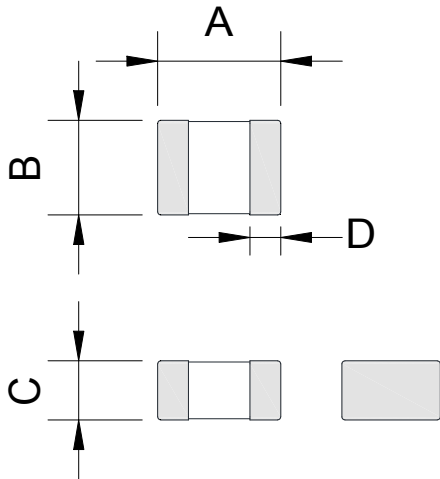

Code	Dimensions
A	2.5±0.25
B	2.0±0.25
C	1.0 Max
D	0.6±0.3

Recommend Land Pattern Dimensions

(Unit: mm)

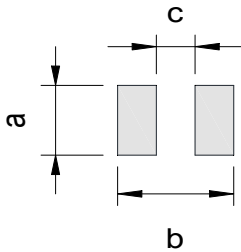

Code	Dimensions
a	2.0 Ref
b	2.8 Ref
c	1.2 Ref

Electrical Characteristics

Part Number	Inductance ¹ (μH)	DCR ² (mΩ) Max	I-sat ³ (Amps)Typ	I-rms ⁴ (Amps)Typ		
MCSM252010AZR47MG	0.47±20%	31.0 Max	6.2	4.6		
MCSM252010AZ1R0MG	1.0±20%	53.0 Max	4.3	3.8		
MCSM252010AZ1R5MG	1.5±20%	81.0 Max	3.6	2.8		
MCSM252010AZ2R2MG	2.2±20%	110.0 Max	2.8	2.5		
MCSM252010AZ4R7MG	4.7±20%	274.0 Max	2.0	1.45		

Note:

- Inductance is measured at 1.0 MHz and 0.5 Vrms at 25°C
- The nominal DCR is measured at 20°C ambient temperature.
- The I-sat that will cause initial inductance value approximately 70% rolloff ,or secure 65% of the nominal L value at 25°C
- The I-rms that will cause temperature rise approximate 40°C without core loss.

※ Withstand DC Voltage : 20.0V Max
 ※ Operating Voltage : 16.0V Max

Mechanical & Dimensions

(Unit: mm)

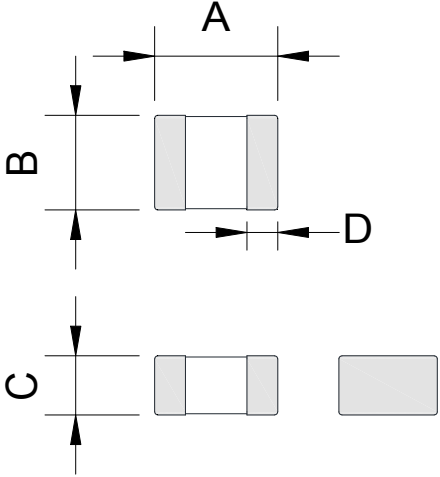
	Code	Dimensions
	A	2.5±0.25
	B	2.0±0.25
	C	1.2 Max
	D	0.6±0.3

Recommend Land Pattern Dimensions

(Unit: mm)

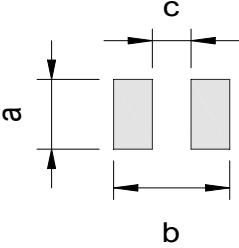
	Code	Dimensions
	a	2.0 Ref
	b	2.8 Ref
	c	1.2 Ref

Electrical Characteristics

Part Number	Inductance ¹ (μH)	DCR ² (mΩ) Max	I-sat ³ (Amps)Typ	I-rms ⁴ (Amps)Typ		
MCSM252012AZR47MC	0.47±20%	39.0 Max	4.7	4.4		
MCSM252012AZ1R0MC	1.0±20%	59.0 Max	3.8	3.5		
MCSM252012AZ1R5MC	1.5±20%	72.0 Max	3.3	2.8		
MCSM252012AZ2R2MC	2.2±20%	108.0 Max	2.7	2.3		
MCSM252012AZ3R3MC	3.3±20%	144.0 Max	2.3	1.7		
MCSM252012AZ4R7MC	4.7±20%	240.0 Max	1.9	1.5		
MCSM252012AZ6R8MC	6.8±20%	375.0 Max	1.6	1.2		

Note:

- Inductance is measured at 1.0 MHz and 0.5 Vrms at 25°C
- The nominal DCR is measured at 20°C ambient temperature.
- The I-sat that will cause initial inductance value approximately 70% rolloff, or secure 65% of the nominal L value at 25°C
- The I-rms that will cause temperature rise approximate 40°C without core loss.

※ Withstand DC Voltage : 20.0V Max
 ※ Operating Voltage : 16.0V Max

Mechanical & Dimensions (Unit: mm)

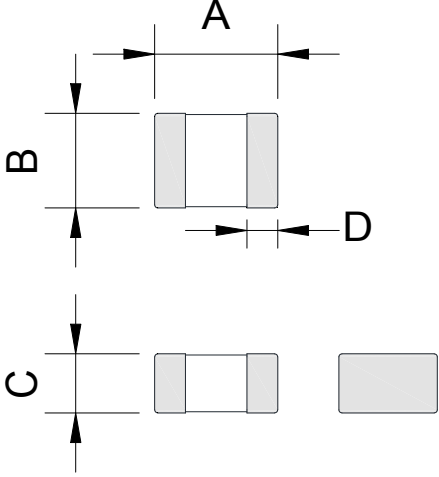
	Code	Dimensions
	A	2.5±0.25
	B	2.0±0.25
	C	1.2 Max
	D	0.6±0.3

Recommend Land Pattern Dimensions (Unit: mm)

	Code	Dimensions
	a	2.0 Ref
	b	2.8 Ref
	c	1.2 Ref

Electrical Characteristics

Part Number	Inductance ¹ (μH)	DCR ² (mΩ) Max	I-sat ³ (Amps)Typ	I-rms ⁴ (Amps)Typ		
MCSM252012AZR47MG	0.47±20%	26.0 Max	6.6	5.5		
MCSM252012AZ1R0MG	1.0±20%	46.0 Max	5.3	4.0		
MCSM252012AZ1R5MG	1.5±20%	68.0 Max	4.6	3.1		
MCSM252012AZ2R2MG	2.2±20%	95.0 Max	3.4	2.7		
MCSM252012AZ4R7MG	4.7±20%	212.0 Max	2.3	1.75		

Note:
 1. Inductance is measured at 1.0 MHz and 0.5 Vrms at 25°C
 2. The nominal DCR is measured at 20°C ambient temperature.
 3. The I-sat that will cause initial inductance value approximately 70% rolloff ,or secure 65% of the nominal L value at 25°C
 4. The I-rms that will cause temperature rise approximate 40°C without core loss.
 ※ Withstand DC Voltage : 20.0V Max
 ※ Operating Voltage : 16.0V Max

Mechanical & Dimensions

(Unit: mm)

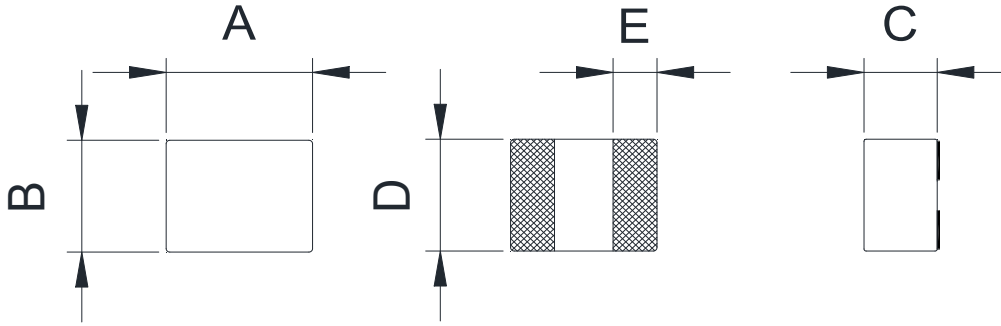

Code	Dimensions
A	1.6 ± 0.2
B	0.8 ± 0.2
C	0.8 Max.
D	1.6 ± 0.2
E	0.6 Typ

Recommend Land Pattern Dimensions

(Unit: mm)

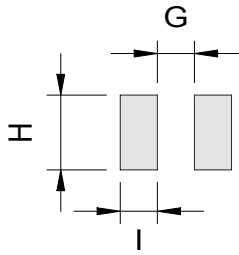

Code	Dimensions
G	0.5 Ref
H	1.5 Ref
I	0.5 Ref

Electrical Characteristics

Part Number	Inductance ¹ (µH)	DCR ² (mΩ) Max	I-sat ³ (Amps)Typ	I-rms ⁴ (Amps)Typ		
MCSM160808BZR22MH	0.22±20%	40.0 Max	5.5	3.4		
MCSM160808BZR47MH	0.47±20%	100.0 Max	4.1	2.6		
MCSM160808BZR56MH	0.56±20%	110.0 Max	4.0	2.2		
MCSM160808BZR68MH	0.68±20%	138.0 Max	3.3	2.2		
MCSM160808BZ1R0MH	1.00±20%	200.0 Max	3.0	2.1		

Note:
 1. Inductance is measured at 100 KHz and 1.0 Vrms at 25°C
 2. The nominal DCR is measured at 25°C ambient temperature.
 3. The I-sat that will cause initial inductance value approximately 70% rolloff, or secure 65% of the nominal L value at 25°C
 4. The I-rms that will cause temperature rise approximate 40°C without core loss.

Mechanical & Dimensions

(Unit: mm)

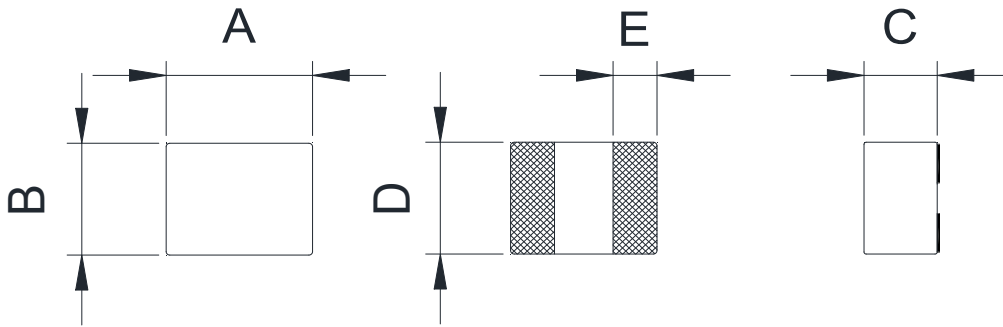

Code	Dimensions
A	1.6 ± 0.2
B	0.8 ± 0.2
C	0.8 Max.
D	1.6 ± 0.2
E	0.6 Typ

Recommend Land Pattern Dimensions

(Unit: mm)

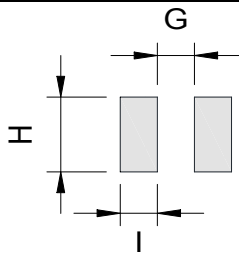

Code	Dimensions
G	0.5 Ref
H	1.5 Ref
I	0.5 Ref

Electrical Characteristics

Part Number	Inductance ¹ (μH)	DCR ² (mΩ) Max	I-sat ³ (Amps)Typ	I-rms ⁴ (Amps)Typ		
MCSM160808BZR47MT	0.47±20%	45.0 Max	4.0	3.8		
MCSM160808BZR56MT	0.56±20%	63.0 Max	3.0	2.5		
MCSM160808BZ1R0MT	1.00±20%	115.0 Max	2.3	2.1		
MCSM160808BZ1R5MT	1.50±20%	285.0 Max	2.4	1.7		
MCSM160808BZ3R3MT	3.30±20%	600.0 Max	1.4	1.0		
MCSM160808BZ4R7MT	4.70±20%	700.0 Max	1.2	1.0		
MCSM160808BZ100MT	10.00±20%	1600.0 Max	0.8	0.5		

Note:
 1. Inductance is measured at 100 KHz and 1.0 Vrms at 25°C
 2. The nominal DCR is measured at 25°C ambient temperature.
 3. The I-sat that will cause initial inductance value approximately 70% rolloff ,or secure 65% of the nominal L value at 25°C
 4. The I-rms that will cause temperature rise approximate 40°C without core loss.

Mechanical & Dimensions

(Unit: mm)

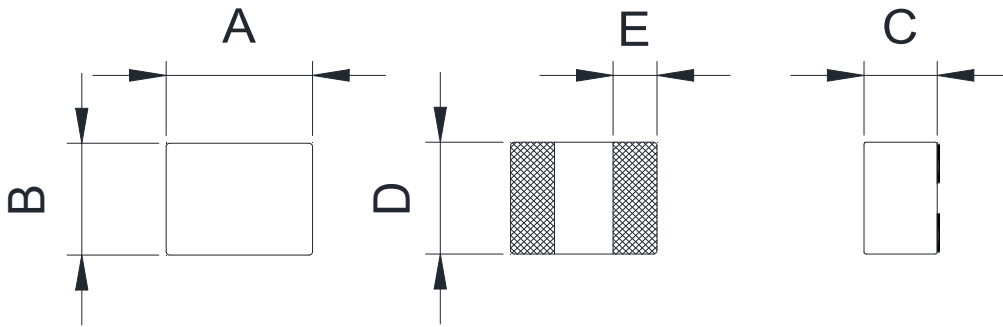

Code	Dimensions
A	2.0±0.2
B	1.2±0.2
C	0.8 Max
D	1.2±0.2
E	0.7 Typ

Recommend Land Pattern Dimensions

(Unit: mm)

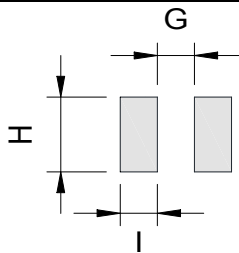

Code	Dimensions
G	0.5 Ref
H	1.3 Ref
I	0.5 Ref

Electrical Characteristics

Part Number	Inductance ¹ (μH)	DCR ² (mΩ) Max	I-sat ³ (Amps)Typ	I-rms ⁴ (Amps)Typ		
MCSM201208BZR24MT	0.24±20%	23.0 Max	6.5	6.5		
MCSM201208BZR33MT	0.33±20%	45.0 Max	5.2	4.3		
MCSM201208BZR47MT	0.47±20%	50.0 Max	5.0	3.5		
MCSM201208BZR68MT	0.68±20%	60.0 Max	4.2	3.7		
MCSM201208BZ1R0MT	1.0±20%	70.0 Max	4.0	3.3		
MCSM201208BZ1R5MT	1.5±20%	135.0 Max	3.0	2.2		
MCSM201208BZ2R2MT	2.2±20%	185.0 Max	2.6	2.2		

Note:
 1. Inductance is measured at 100 KHz and 1.0 Vrms at 25°C
 2. The nominal DCR is measured at 25°C ambient temperature.
 3. The I-sat that will cause initial inductance value approximately 70% rolloff ,or secure 65% of the nominal L value at 25°C
 4. The I-rms that will cause temperature rise approximate 40°C without core loss.

Mechanical & Dimensions

(Unit: mm)

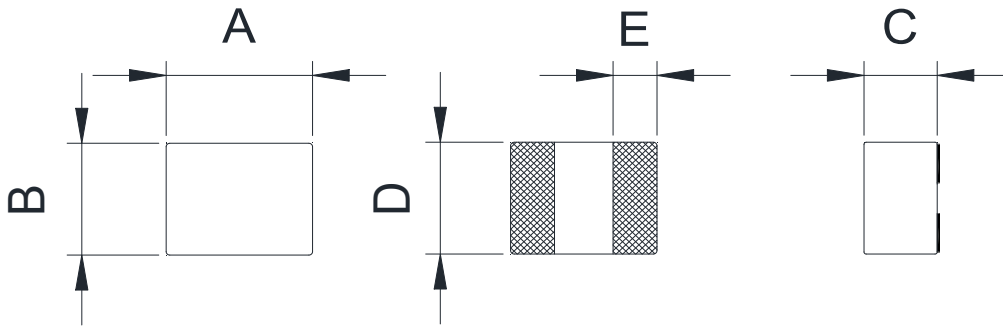

Code	Dimensions
A	2.0±0.2
B	1.2±0.2
C	1.0 Max
D	1.2±0.2
E	0.7 Typ

Recommend Land Pattern Dimensions

(Unit: mm)

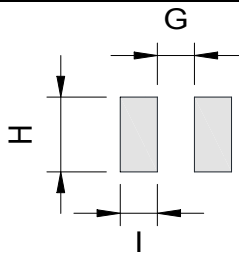

Code	Dimensions
G	0.5 Ref
H	1.5 Ref
I	0.5 Ref

Electrical Characteristics

Part Number	Inductance ¹ (μH)	DCR ² (mΩ) Max	I-sat ³ (Amps)Typ	I-rms ⁴ (Amps)Typ		
MCSM201210BZR10MT	0.10±20%	13.0 Max	8.5	7.5		
MCSM201210BZR22MT	0.22±20%	22.0 Max	7.3	7.1		
MCSM201210BZR24MT	0.24±20%	23.0 Max	7.2	7.0		
MCSM201210BZR33MT	0.33±20%	32.0 Max	6.5	5.5		
MCSM201210BZR47MT	0.47±20%	36.0 Max	5.5	4.7		
MCSM201210BZR68MT	0.68±20%	43.0 Max	5.0	4.3		
MCSM201210BZ1R0MT	1.00±20%	63.0 Max	4.0	3.9		
MCSM201210BZ1R5MT	1.50±20%	85.0 Max	3.2	3.1		
MCSM201210BZ2R2MT	2.20±20%	150.0 Max	2.7	2.0		

Note:
 1. Inductance is measured at 100 KHz and 1.0 Vrms at 25°C
 2. The nominal DCR is measured at 25°C ambient temperature.
 3. The I-sat that will cause initial inductance value approximately 70% rolloff ,or secure 65% of the nominal L value at 25°C
 4. The I-rms that will cause temperature rise approximate 40°C without core loss.

Mechanical & Dimensions

(Unit: mm)

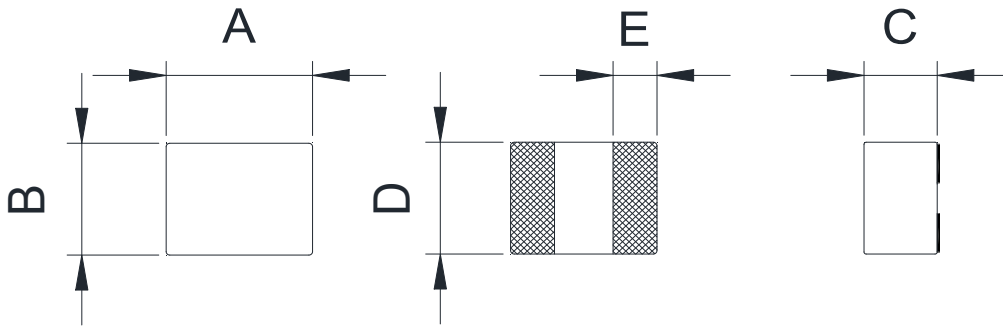

Code	Dimensions
A	2.5±0.2
B	2.0±0.2
C	1.0 Max
D	2.0±0.2
E	0.6±0.3

Recommend Land Pattern Dimensions

(Unit: mm)

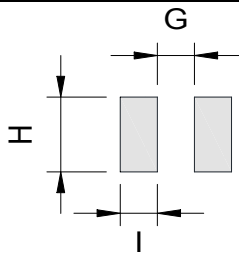

Code	Dimensions
G	1.2 Ref
H	2.0 Ref
I	0.8 Ref

Electrical Characteristics

Part Number	Inductance ¹ (μH)	DCR ² (mΩ) Max	I-sat ³ (Amps)Typ	I-rms ⁴ (Amps)Typ		
MCSM252010BZR33MT	0.33±20%	22.0 Max	8.5	6.5		
MCSM252010BZR47MT	0.47±20%	25.0 Max	6.5	4.5		
MCSM252010BZ1R0MT	1.0±20%	52.0 Max	4.5	3.5		
MCSM252010BZ1R5MT	1.5±20%	105.0 Max	3.5	3.0		
MCSM252010BZ2R2MT	2.2±20%	118.0 Max	3.0	2.3		
MCSM252010BZ3R3MT	3.3±20%	175.0 Max	2.3	1.8		
MCSM252010BZ4R7MT	4.7±20%	235.0 Max	1.8	1.6		

Note:
 1. Inductance is measured at 100 KHz and 1.0 Vrms at 25°C
 2. The nominal DCR is measured at 25°C ambient temperature.
 3. The I-sat that will cause initial inductance value approximately 70% rolloff ,or secure 65% of the nominal L value at 25°C
 4. The I-rms that will cause temperature rise approximate 40°C without core loss.

Mechanical & Dimensions

(Unit: mm)

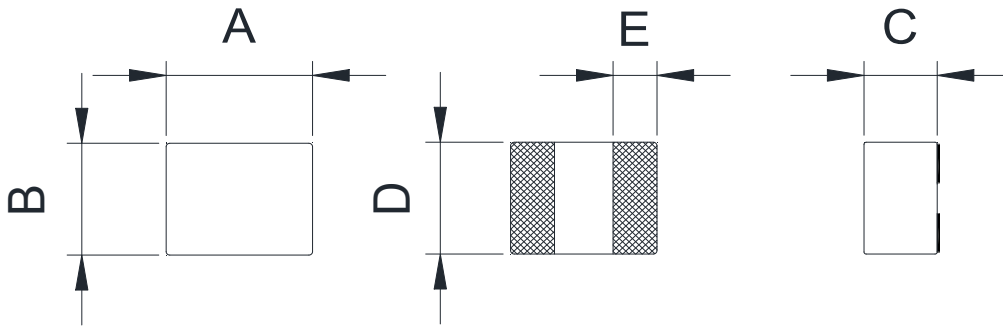

Code	Dimensions
A	2.0±0.2
B	1.6±0.2
C	1.0 Max
D	1.6±0.2
E	0.6±0.2

Recommend Land Pattern Dimensions

(Unit: mm)

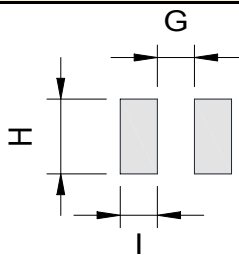

Code	Dimensions
G	0.7 Ref
H	2.0 Ref
I	0.8 Ref

Electrical Characteristics

Part Number	Inductance ¹ (μH)	DCR ² (mΩ) Max	I-sat ³ (Amps)Typ	I-rms ⁴ (Amps)Typ		
MCSM201610BZR24MT	0.24±20%	20.0 Max	7.2	6.3		
MCSM201610BZR33MT	0.33±20%	30.0 Max	7.1	5.0		
MCSM201610BZR47MT	0.47±20%	35.0 Max	6.5	5.8		
MCSM201610BZR68MT	0.68±20%	52.0 Max	4.5	4.0		
MCSM201610BZ1R0MT	1.0±20%	76.0 Max	3.5	3.0		
MCSM201610BZ1R5MT	1.5±20%	120.0 Max	3.0	2.1		
MCSM201610BZ2R2MT	2.2±20%	204.0 Max	2.4	1.6		

Note:
 1. Inductance is measured at 100 KHz and 1.0 Vrms at 25°C
 2. The nominal DCR is measured at 25°C ambient temperature.
 3. The I-sat that will cause initial inductance value approximately 70% rolloff ,or secure 65% of the nominal L value at 25°C
 4. The I-rms that will cause temperature rise approximate 40°C without core loss.

Mechanical & Dimensions

(Unit: mm)

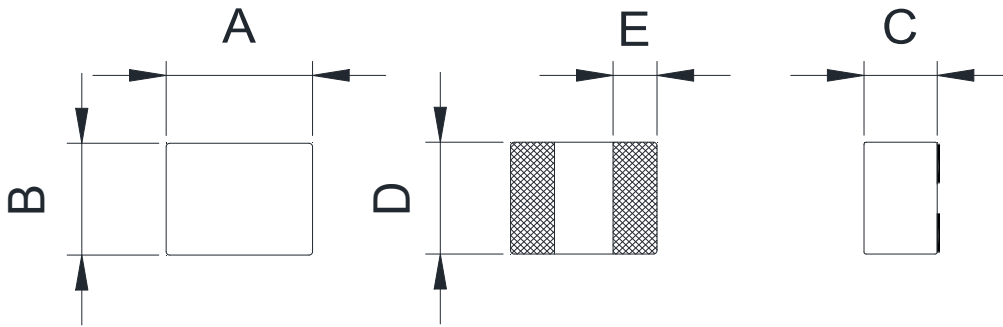

Code	Dimensions
A	2.5±0.2
B	2.0±0.2
C	1.2 Max
D	2.0±0.2
E	0.6±0.3

Recommend Land Pattern Dimensions

(Unit: mm)

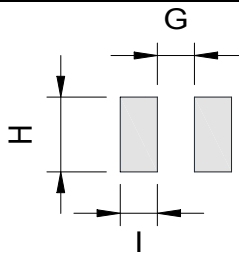

Code	Dimensions
G	1.2 Ref
H	2.0 Ref
I	0.8 Ref

Electrical Characteristics

Part Number	Inductance ¹ (μH)	DCR ² (mΩ) Max	I-sat ³ (Amps)Typ	I-rms ⁴ (Amps)Typ		
MCSM252012BZR22MT	0.22±20%	13.0 Max	10.0	9.0		
MCSM252012BZR33MT	0.33±20%	20.0 Max	8.3	6.8		
MCSM252012BZR47MT	0.47±20%	26.0 Max	8.0	5.5		
MCSM252012BZR68MT	0.68±20%	35.0 Max	6.5	5.2		
MCSM252012BZ1R0MT	1.00±20%	37.0 Max	5.5	5.0		
MCSM252012BZ1R5MT	1.5±20%	70.0 Max	5.0	3.2		
MCSM252012BZ2R2MT	2.2±20%	92.0 Max	3.5	2.6		
MCSM252012BZ3R3MT	3.3±20%	138.0 Max	3.0	2.0		
MCSM252012BZ4R7MT	4.7±20%	190.0 Max	2.5	1.8		

Note:
 1. Inductance is measured at 100 KHz and 1.0 Vrms at 25°C
 2. The nominal DCR is measured at 25°C ambient temperature.
 3. The I-sat that will cause initial inductance value approximately 70% rolloff, or secure 65% of the nominal L value at 25°C
 4. The I-rms that will cause temperature rise approximate 40°C without core loss.

Mechanical & Dimensions

(Unit: mm)

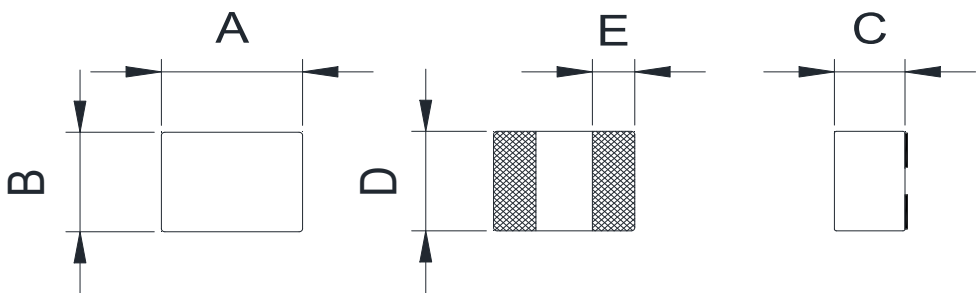
	Code	Dimensions
	A	3.2±0.2
	B	2.5±0.2
	C	see table
	D	2.5±0.2
	E	1.0±0.2

Recommend Land Pattern Dimensions

(Unit: mm)

	Code	Dimensions
	G	1.1 Ref
	H	2.8 Ref
	I	1.2 Ref

Electrical Characteristics

Part Number	Inductance ¹ (μH)	DCR ² (mΩ) Max	I-sat ³ (Amps)Typ	I-rms ⁴ (Amps)Typ	C Dim.
MCSM322510BZ1R0MT	1.0±20%	48.0 Max	6.0	4.0	1.0
MCSM322512BZR10MT	0.10±20%	13.0 Max	16.0	8.5	1.2
MCSM322512BZR22MT	0.22±20%	14.0 Max	11.5	9.2	1.2
MCSM322512BZR47MT	0.47±20%	24.0 Max	12.0	6.0	1.2
MCSM322512BZR47MT8A6	0.47±20%	19.0 Max	8.6	7.5	1.2
MCSM322512BZR56MT	0.56±20%	30.0 Max	10.0	5.0	1.2
MCSM322512BZR68MT	0.68±20%	32.0 Max	8.0	4.5	1.2
MCSM322512BZ1R0MT	1.00±20%	35.0 Max	7.0	4.0	1.2
MCSM322512BZ1R5MT	1.50±20%	44.0 Max	5.1	4.7	1.2
MCSM322512BZ2R2MT	2.20±20%	75.0 Max	4.5	3.0	1.2
MCSM322512BZ3R3MT	3.30±20%	127.0 Max	3.5	2.5	1.2
MCSM322512BZ4R7MT	4.70±20%	192.0 Max	3.0	2.0	1.2
MCSM322512BZ100MT	10.00±20%	322.0 Max	2.5	1.8	1.2
MCSM322520BZR68MT	0.68±20%	16.0 Max	11.0	6.5	2.0
MCSM322520BZ1R0MT	1.00±20%	22.0 Max	10.0	5.4	2.0
MCSM322520BZ1R5MT	1.50±20%	31.0 Max	6.8	6.5	2.0
MCSM322520BZ2R2MT	2.20±20%	46.0 Max	6.5	5.4	2.0
MCSM322520BZ3R3MT	3.30±20%	65.0 Max	4.5	4.5	2.0
MCSM322520BZ4R7MT	4.70±20%	120.0 Max	4.0	3.5	2.0
MCSM322520BZ6R8MT	6.80±20%	170.0 Max	3.8	2.8	2.0
MCSM322515BZR22MT	0.22±20%	7.9 Max	11.0	13.0	1.5

Note:

1. Inductance is measured at 100 KHz and 1.0 Vrms at 25°C
2. The nominal DCR is measured at 25°C ambient temperature.
3. The I-sat that will cause initial inductance value approximately 70% rolloff, or secure 65% of the nominal L value at 25°C
4. The I-rms that will cause temperature rise approximate 40°C without core loss.

Mechanical & Dimensions

(Unit: mm)

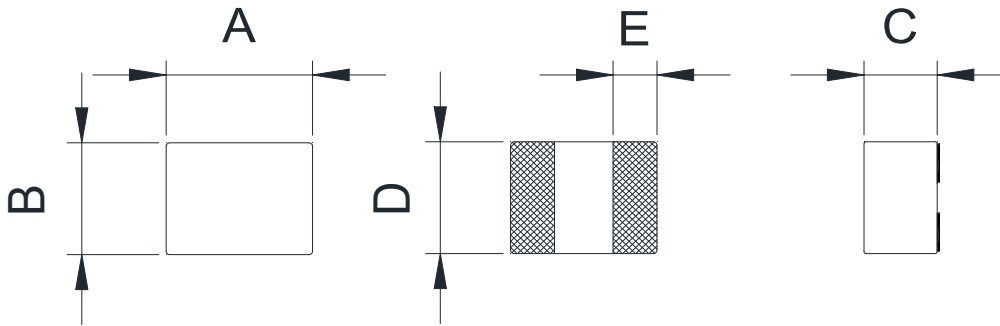

Code	Dimensions
A	4.0±0.3
B	4.0±0.3
C	1.0 Max
D	4.0±0.3
E	1.2±0.3

Recommend Land Pattern Dimensions

(Unit: mm)

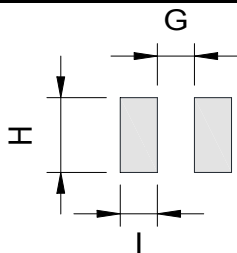

Code	Dimensions
G	1.5 Ref
H	4.3 Ref
I	1.5 Ref

Electrical Characteristics

Part Number	Inductance ¹ (μH)	DCR ² (mΩ) Max	I-sat ³ (Amps)Typ	I-rms ⁴ (Amps)Typ		
MCSM41BZ1R0MT	1.0±20%	46.0 Max	7.0	3.5		
MCSM41BZ1R5MT	1.5±20%	70.0 Max	5.0	3.4		
MCSM41BZ2R2MT	2.2±20%	85.0 Max	4.5	3.2		
MCSM41BZ3R3MT	3.3±20%	120.0 Max	4.0	2.8		
MCSM41BZ4R7MT	4.7±20%	160.0 Max	3.0	2.5		
MCSM41BZ6R8MT	6.8±20%	185.0 Max	2.5	2.0		
MCSM41BZ100MT	10.0±20%	330.0 Max	2.0	1.5		

Note:
 1. Inductance is measured at 100 KHz and 1.0 Vrms at 25°C
 2. The nominal DCR is measured at 25°C ambient temperature.
 3. The I-sat that will cause initial inductance value approximately 70% rolloff ,or secure 65% of the nominal L value at 25°C
 4. The I-rms that will cause temperature rise approximate 40°C without core loss.

Mechanical & Dimensions

(Unit: mm)

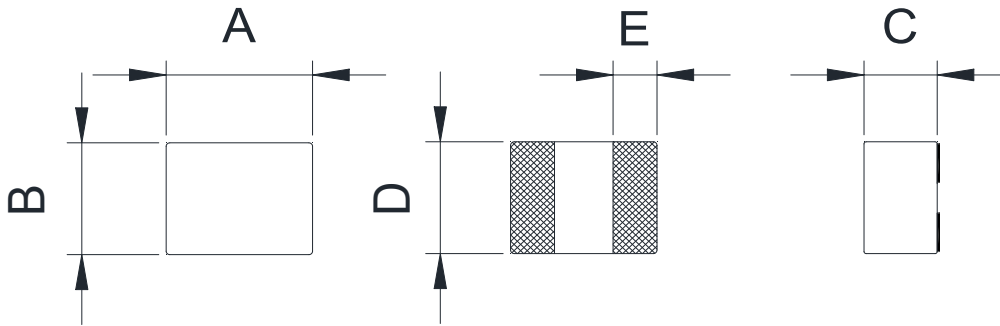

Code	Dimensions
A	4.0±0.3
B	4.0±0.3
C	1.2 Max
D	4.0±0.3
E	1.2±0.3

Recommend Land Pattern Dimensions

(Unit: mm)

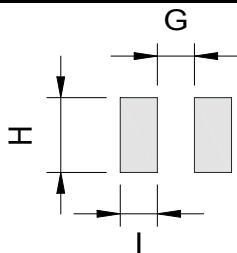

Code	Dimensions
G	1.5 Ref
H	4.3 Ref
I	1.5 Ref

Electrical Characteristics

Part Number	Inductance ¹ (μH)	DCR ² (mΩ) Max	I-sat ³ (Amps)Typ	I-rms ⁴ (Amps)Typ		
MCSM412BZR25MT	0.25±20%	10.0 Max	11.0	8.0		
MCSM412BZR47MT	0.47±20%	25.0 Max	9.5	7.0		
MCSM412BZR68MT	0.68±20%	30.0 Max	8.0	6.0		
MCSM412BZ1R0MT	1.0±20%	33.0 Max	7.0	5.0		
MCSM412BZ1R5MT	1.5±20%	55.0 Max	6.5	4.2		
MCSM412BZ2R2MT	2.2±20%	63.0 Max	6.0	4.0		
MCSM412BZ3R3MT	3.3±20%	90.0 Max	5.0	3.5		
MCSM412BZ4R7MT	4.7±20%	110.0 Max	4.5	3.0		
MCSM412BZ5R6MT	5.6±20%	140.0 Max	4.0	2.5		
MCSM412BZ6R8MT	6.8±20%	160.0 Max	3.5	2.3		
MCSM412BZ100MT	10.0±20%	240.0 Max	2.5	1.8		

Note:

1. Inductance is measured at 100 KHz and 1.0 Vrms at 25°C
2. The nominal DCR is measured at 25°C ambient temperature.
3. The I-sat that will cause initial inductance value approximately 70% rolloff, or secure 65% of the nominal L value at 25°C
4. The I-rms that will cause temperature rise approximate 40°C without core loss.

Mechanical & Dimensions (Unit: mm)

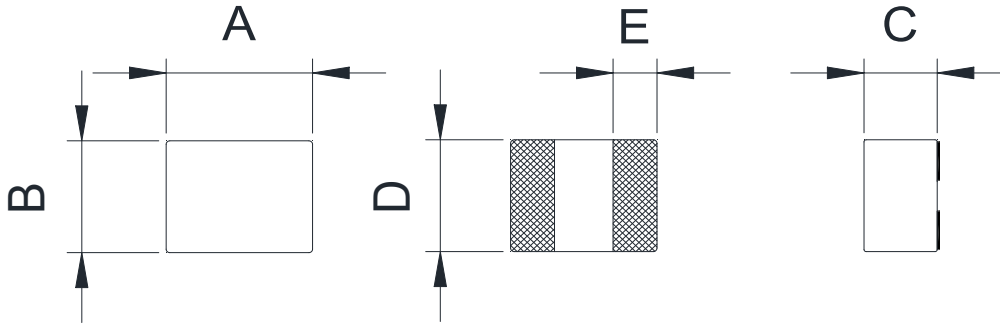

Code	Dimensions
A	4.0±0.3
B	4.0±0.3
C	1.5 Max
D	4.0±0.3
E	1.2±0.3

Recommend Land Pattern Dimensions (Unit: mm)

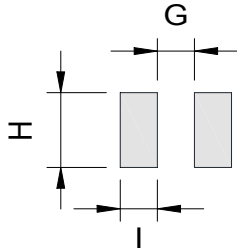

Code	Dimensions
G	1.5 Ref
H	4.3 Ref
I	1.5 Ref

Electrical Characteristics

Part Number	Inductance ¹ (μH)	DCR ² (mΩ) Max	I-sat ³ (Amps)Typ	I-rms ⁴ (Amps)Typ		
MCSM415BZR47MT	0.47±20%	15.0 Max	10.0	9.2		
MCSM415BZ2R2MT	2.20±20%	39.8 Max	6.5	6.0		

Note:
 1. Inductance is measured at 100 KHz and 1.0 Vrms at 25°C
 2. The nominal DCR is measured at 25°C ambient temperature.
 3. The I-sat that will cause initial inductance value approximately 70% rolloff ,or secure 65% of the nominal L value at 25°C
 4. The I-rms that will cause temperature rise approximate 40°C without core loss.

Mechanical & Dimensions (Unit: mm)

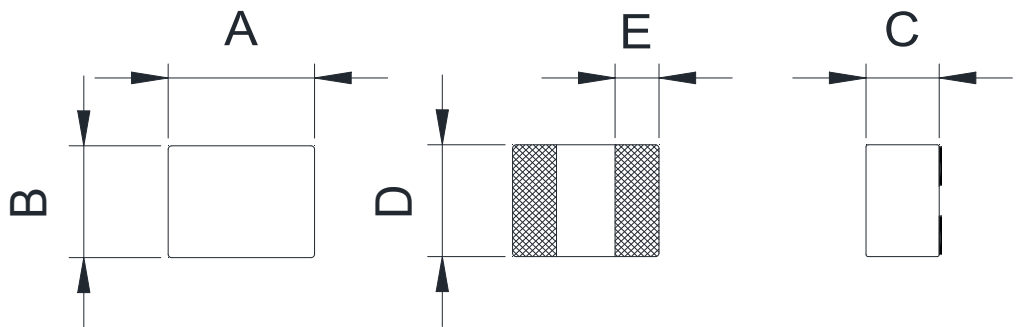
	Code	Dimensions
	A	4.0±0.3
	B	4.0±0.3
	C	2.0 Max
	D	4.0±0.3
	E	1.2±0.3

Recommend Land Pattern Dimensions (Unit: mm)

	Code	Dimensions
	G	1.5 Ref
	H	4.3 Ref
	I	1.5 Ref

Electrical Characteristics

Part Number	Inductance ¹ (μH)	DCR ² (mΩ) Max	I-sat ³ (Amps)Typ	I-rms ⁴ (Amps)Typ		
MCSM42BZR33MT	0.33±20%	8.0 Max	20.0	13.0		
MCSM42BZR47MT	0.47±20%	9.0 Max	18.0	12.0		
MCSM42BZR68MT	0.68±20%	13.0 Max	15.0	10.0		
MCSM42BZ1R0MT	1.0±20%	8.9 Max	11.0	14.0		
MCSM42BZ1R5MT	1.5±20%	20.0 Max	10.0	6.0		
MCSM42BZ2R2MT	2.2±20%	34.0 Max	8.0	5.0		
MCSM42BZ3R3MT	3.3±20%	43.0 Max	6.0	4.5		
MCSM42BZ4R7MT	4.7±20%	63.0 Max	5.5	4.0		
MCSM42BZ220MT	22.0±20%	295.0 Max	2.5	1.5		

Note:

- Inductance is measured at 100 KHz and 1.0 Vrms at 25°C
- The nominal DCR is measured at 25°C ambient temperature.
- The I-sat that will cause initial inductance value approximately 70% rolloff ,or secure 65% of the nominal L value at 25°C
- The I-rms that will cause temperature rise approximate 40°C without core loss.

Mechanical & Dimensions (Unit: mm)

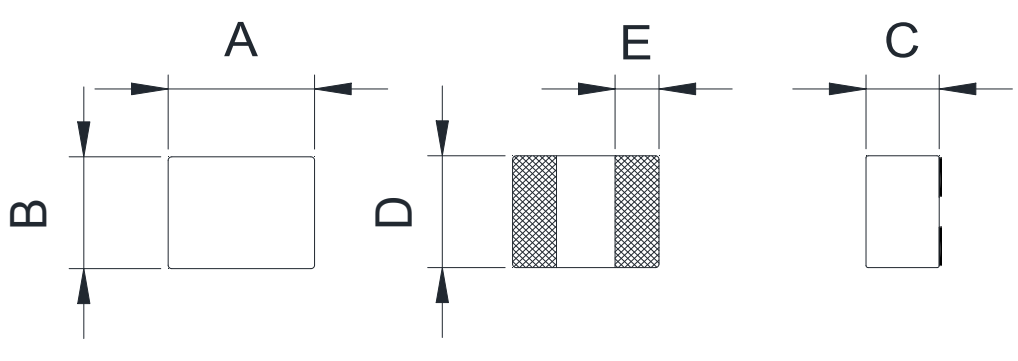
	Code	Dimensions
	A	4.0±0.3
	B	4.0±0.3
	C	3.0 Max
	D	4.0±0.3
	E	1.2±0.3

Recommend Land Pattern Dimensions (Unit: mm)

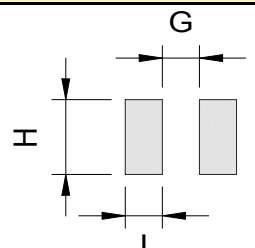
	Code	Dimensions
	G	1.5 Ref
	H	4.3 Ref
	I	1.5 Ref

Electrical Characteristics

Part Number	Inductance ¹ (μH)	DCR ² (mΩ) Max	I-sat ³ (Amps)Typ	I-rms ⁴ (Amps)Typ		
MCSM43BZ6R8MT	6.8±20%	120.0 Max	4.0	2.5		

Note:
 1. Inductance is measured at 100 KHz and 1.0 Vrms at 25°C
 2. The nominal DCR is measured at 25°C ambient temperature.
 3. The I-sat that will cause initial inductance value approximately 70% rolloff ,or secure 65% of the nominal L value at 25°C
 4. The I-rms that will cause temperature rise approximate 40°C without core loss.

Mechanical & Dimensions (Unit: mm)

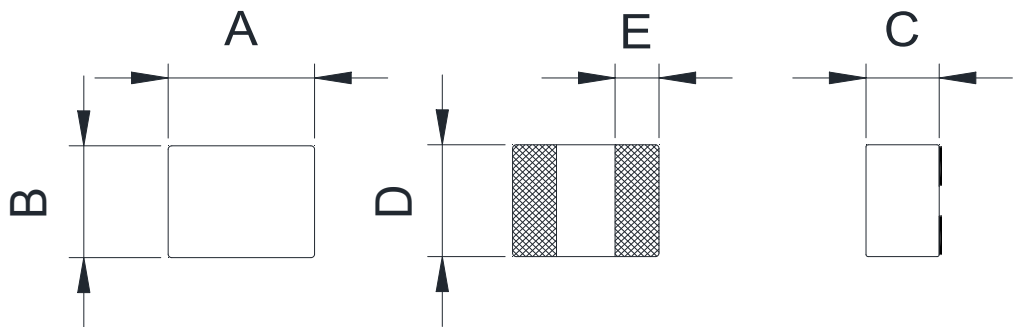
	Code	Dimensions
	A	4.0±0.3
	B	4.0±0.3
	C	4.0 Max
	D	4.0±0.3
	E	1.2±0.3

Recommend Land Pattern Dimensions (Unit: mm)

	Code	Dimensions
	G	1.5 Ref
	H	4.3 Ref
	I	1.5 Ref

Electrical Characteristics

Part Number	Inductance ¹ (μH)	DCR ² (mΩ) Max	I-sat ³ (Amps)Typ	I-rms ⁴ (Amps)Typ
MCSM44BZR15MT	0.15±20%	1.8 Max	21.0	30.2
MCSM44BZR30MT	0.30±20%	2.6 Max	15.3	24.6
MCSM44BZR47MT	0.47±20%	3.2 Max	12.2	20.8
MCSM44BZR68MT	0.68±20%	4.0 Max	10.5	18.3
MCSM44BZ1R0MT	1.00±20%	5.6 Max	9.3	14.8
MCSM44BZ1R5MT	1.50±20%	7.9 Max	7.9	12.5
MCSM44BZ2R2MT	2.20±20%	11.5 Max	6.4	11.0
MCSM44BZ3R3MT	3.30±20%	16.6 Max	5.5	8.7
MCSM44BZ4R7MT	4.70±20%	24.5 Max	4.4	7.1
MCSM44BZ6R8MT	6.80±20%	34.7 Max	4.0	5.6
MCSM44BZ100MT	10.00±20%	50.5 Max	2.8	5.0

Note:
 1. Inductance is measured at 100 KHz and 1.0 Vrms at 25°C
 2. The nominal DCR is measured at 25°C ambient temperature.
 3. The I-sat that will cause initial inductance value approximately 70% rolloff, or secure 65% of the nominal L value at 25°C
 4. The I-rms that will cause temperature rise approximate 40°C without core loss.

Mechanical & Dimensions (Unit: mm)

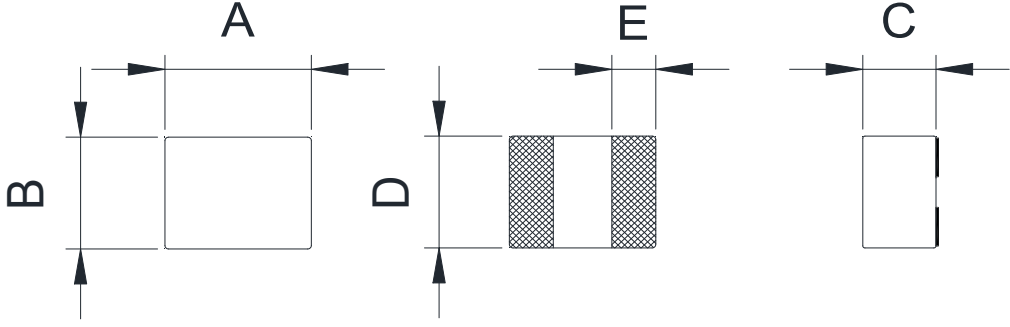
	Code	Dimensions
	A	5.2±0.2
	B	5.4±0.2
	C	2.8±0.3
	D	5.4±0.2
	E	1.6±0.3

Recommend Land Pattern Dimensions (Unit: mm)

	Code	Dimensions
	G	2.2 Ref
	H	5.8 Ref
	I	1.8 Ref

Electrical Characteristics

Part Number	Inductance ¹ (μH)	DCR ² (mΩ)	I-sat ³ (Amps)Typ	I-rms ⁴ (Amps)Typ		
MCSM53BZR15MT	0.15±20%	0.74±7%	45.0	38.0		
MCSM53BZR33MT	0.33±20%	2.1 Max	21.0	20.0		
MCSM53BZ1R5MT	1.50±20%	11.0 Max	14.0	12.0		
MCSM53BZ100MT	10.0±20%	65.0 Max	5.0	4.0		

Note:
 1. Inductance is measured at 100 KHz and 1.0 Vrms at 25°C
 2. The nominal DCR is measured at 25°C ambient temperature.
 3. The I-sat that will cause initial inductance value approximately 70% rolloff ,or secure 65% of the nominal L value at 25°C
 4. The I-rms that will cause temperature rise approximate 40°C without core loss.
 5. The sensitivity R15 test DCR was 0.8±5% at the center point

Packaging

Reel Dimension:

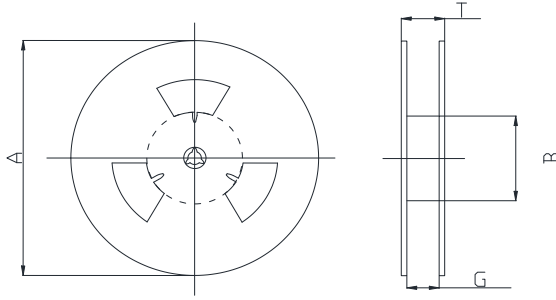

P/N	Type	A(mm)	B(mm)	G(mm)	T(mm)	Chip/Reel
MCSM201610A-B	8" x 8mm	180	60	8.4	14.4	3000
MCSM252010A-C	8" x 8mm	180	60	8.4	14.4	3000
MCSM252010A-G	8" x 8mm	180	60	8.4	14.4	3000
MCSM252012A-C	8" x 8mm	180	60	8.4	14.4	3000
MCSM252012A-G	8" x 8mm	180	60	8.4	14.4	3000
MCSM160808B-H	7" x 8mm	178	100	9	12	3000
MCSM201208B-T	7" x 8mm	178	100	9	12	3000
MCSM201210B-T	7" x 8mm	178	100	9	12	3000
MCSM201610B-T	7" x 8mm	178	100	9	12	3000
MCSM252010B-T	7" x 8mm	178	100	9	12	3000
MCSM252012B-T	7" x 8mm	178	100	9	12	3000
MCSM3225xxB-T	7" x 8mm	178	100	9	12	3000
MCSM322520B-T	7" x 8mm	178	100	9	12	2000
MCSM41B-T	13" x 12mm	330	100	12.5	16.9	4000
MCSM412B-T	13" x 12mm	330	100	12.5	16.9	4000
MCSM415B-T	13" x 12mm	330	100	12.5	16.9	3000
MCSM42B-T	13" x 12mm	330	100	12.5	16.9	3000
MCSM43B-T	13" x 12mm	330	100	12.5	16.9	2000
MCSM44B-T	13" x 12mm	330	100	12.5	16.9	1500
MCSM53B-T	13" x 12mm	330	100	12.5	16.9	2000

Packaging

Tape Dimension:

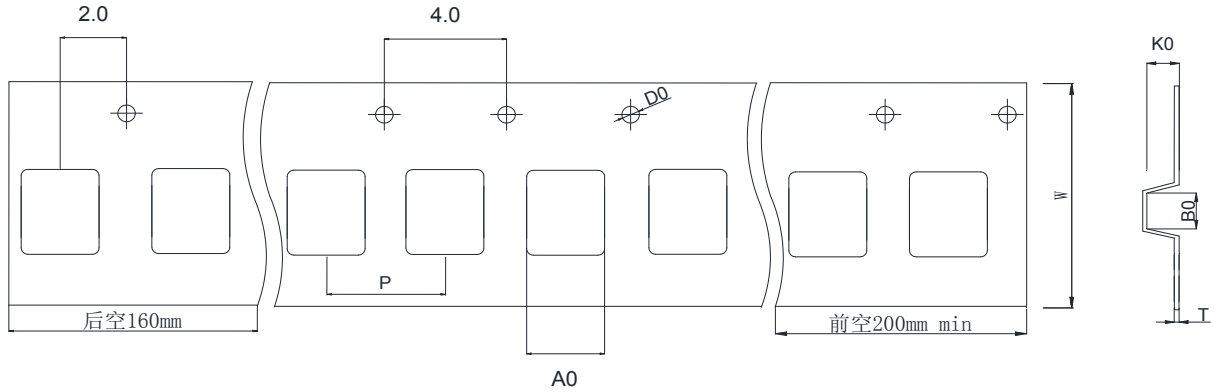

P/N	Ao	Bo	Ko	P	W	D0				
MCSM201610A-B	1.9±0.1	2.3±0.1	1.1±0.1	4.0±0.1	8.0±0.2	Φ1.5				
MCSM252010A-C	2.2±0.1	2.75±0.1	1.1±0.1	4.0±0.1	8.0±0.2	Φ1.5				
MCSM252010A-G	2.2±0.1	2.75±0.1	1.1±0.1	4.0±0.1	8.0±0.2	Φ1.5				
MCSM252012A-C	2.2±0.1	2.75±0.1	1.3±0.1	4.0±0.1	8.0±0.2	Φ1.5				
MCSM252012A-G	2.2±0.1	2.75±0.1	1.3±0.1	4.0±0.1	8.0±0.2	Φ1.5				
MCSM160808B-H	1.8±0.1	2.2±0.1	1.2±0.1	4.0±0.1	8.0±0.3	Φ1.5				
MCSM201208B-T	2.2±0.1	2.8±0.1	1.5±0.1	4.0±0.1	8.0±0.3	Φ1.5				
MCSM201210B-T	2.2±0.1	2.8±0.1	1.5±0.1	4.0±0.1	8.0±0.3	Φ1.5				
MCSM201610B-T	1.8±0.1	2.2±0.1	1.2±0.1	4.0±0.1	8.0±0.3	Φ1.5				
MCSM252010B-T	2.2±0.1	2.8±0.1	1.5±0.1	4.0±0.1	8.0±0.3	Φ1.5				
MCSM252012B-T	2.2±0.1	2.8±0.1	1.5±0.1	4.0±0.1	8.0±0.3	Φ1.5				
MCSM3225xxB-T	2.8±0.1	3.6±0.1	see note	4.0±0.1	8.0±0.3	Φ1.5				
MCSM41B-T	4.4±0.1	5.2±0.1	1.5±0.1	8.0±0.1	12.0±0.3	Φ1.5				
MCSM412B-T	4.4±0.1	5.2±0.1	1.5±0.1	8.0±0.1	12.0±0.3	Φ1.5				
MCSM415B-T	4.4±0.1	5.2±0.1	2.2±0.1	8.0±0.1	12.0±0.3	Φ1.5				
MCSM42B-T	4.4±0.1	5.2±0.1	2.2±0.1	8.0±0.1	12.0±0.3	Φ1.5				
MCSM43B-T	4.4±0.1	5.2±0.1	3.2±0.1	8.0±0.1	12.0±0.3	Φ1.5				
MCSM44B-T	4.4±0.1	5.2±0.1	4.2±0.1	8.0±0.1	12.0±0.3	Φ1.5				
MCSM53B-T	5.4±0.1	5.9±0.1	3.3±0.1	8.0±0.1	12.0±0.3	Φ1.5				

Note:

1.MCSM322510 : K0 = 1.5±0.1 ; MCSM322512 : K0 = 1.5±0.1 ; MCSM322520 : K0 = 2.2±0.1

Packaging

Tearing Off Force:

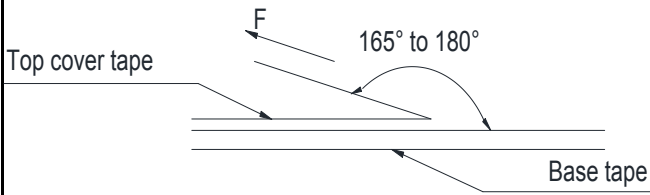

The force tearing off cobe tape is 10 to 130 g.f			
in the arrow direction under the following conditions			
Room Temp ($^\circ\text{C}$)	Room Humidity (%)	Room atrn (hPa)	Teaming Speed (mm/min)
5~35	45~85	860~1060	300

※Storage Conditions

1. Temperature and humidity conditions:
-40 $^\circ\text{C}$ ~ +85 $^\circ\text{C}$ and 70% RH.
2. Recommended products should be used within 6 months form the time of delivery.
3. The packaging material should be kept where no chlorine or sulfur exists in the air.

※Transportation

1. Products should be handled with care to avoid damage or contamination from perspiration and skin oils.
2. The use of tweezers or vacuum pick up is strongly recommended for individual components.
3. Bulk handling should ensure that abrasion and mechanical shock are minimized.

Recommended Soldering Conditions

Figure 1. Re-flow Soldering

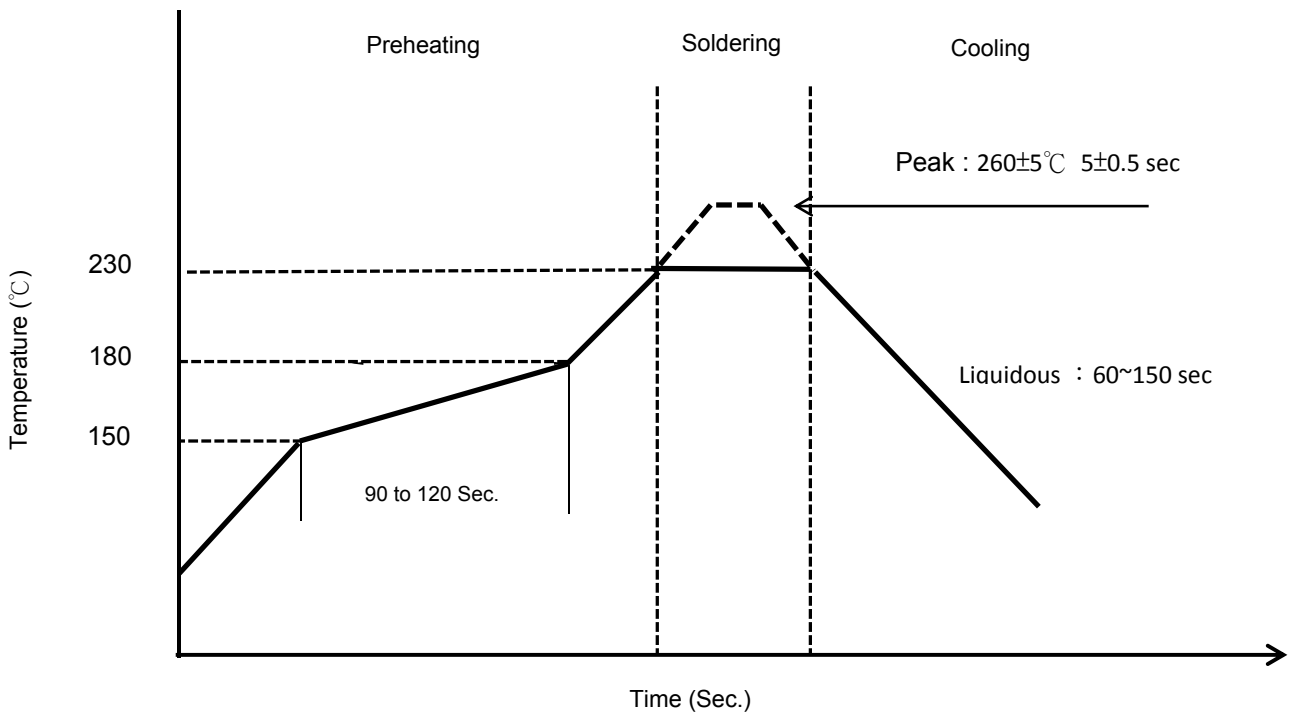
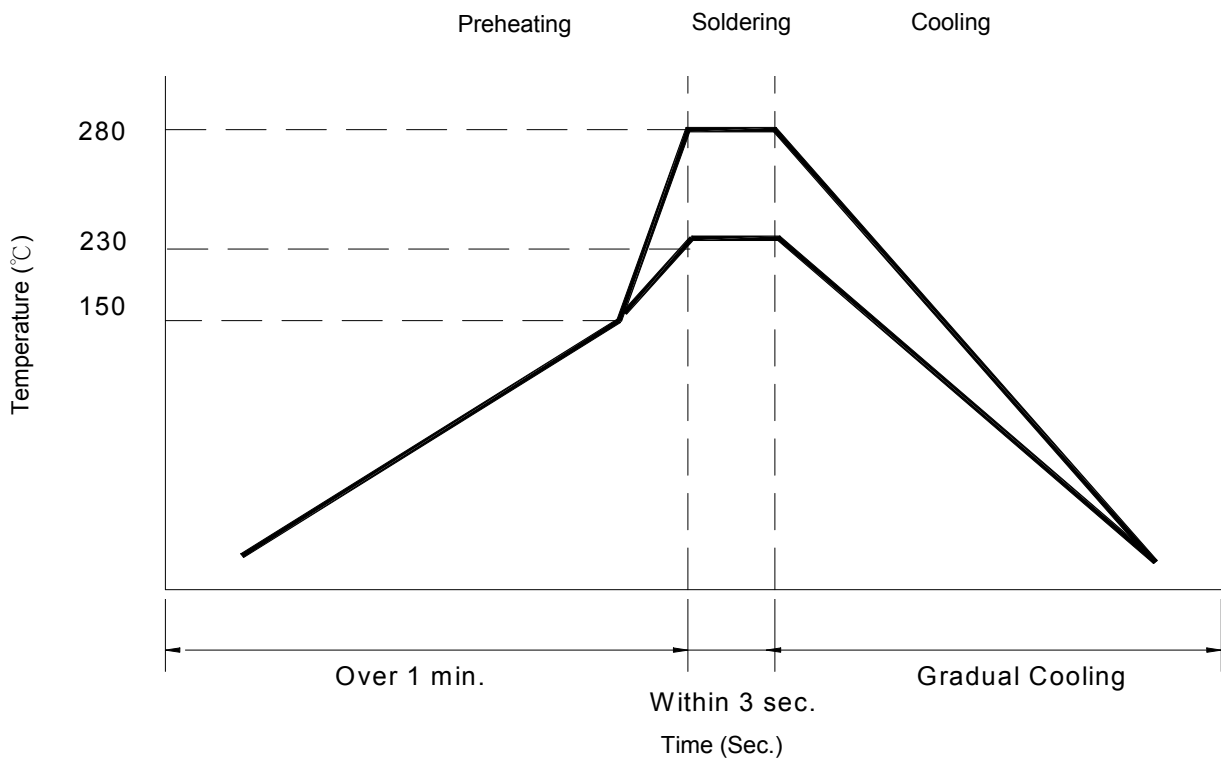
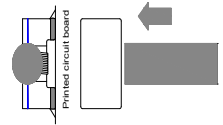

Figure 2. Hand Soldering



Reliability and Testing Conditions																	
Item	Specification	Conditions															
Operating temperature range	-40°C ~ +125°C (Including self-temperature rise)																
Storage temperature and humidity range	+5°C ~ +40°C , 70% RH Max																
Solderability	More than 90% of the terminal electrode should be covered with solder.	<ul style="list-style-type: none"> - Preheat: 150 °C, 90±30 sec - Solder: Sn96.5%-Ag3%-Cu0.5% - Temperature: 245±5°C - Flux for lead free: Rosin 9.5% - Dip time: 4±1 sec - Depth: completely cover the termination 															
Resistance to Soldering Heat	Inductance within ±20% of initial value. No disconnection or short circuit. The appearance shall not break.	<ul style="list-style-type: none"> - Solder technique simulation: SMD - Temperature (°C): 260 ± 5 (solder temp) - Time (s): 10 ± 1 - Temperature ramp / immersion and emersion rate: 25 mm/s ± 6 mm/s - Number of heat cycles: 1 															
Resistance to High Temperature	Inductance within ±20% of initial value. No disconnection or short circuit. The appearance shall not break.	500 hrs. at 85°C±2°C Unpowered. Measurement at 24±4 hours after test conclusion.															
Resistance to Low Temperature	Inductance within ±20% of initial value. No disconnection or short circuit. The appearance shall not break.	500 hrs. at -40°C±3°C. Unpowered. Measurement at 24±4 hours after test conclusion.															
Resistance to Humidity	Inductance within ±20% of initial value. No disconnection or short circuit. The appearance shall not break.	After 500 hours in 40±2°C and 90 to 95% humidity , and 24±4 hours drying under normal condition.															
Thermal shock	Inductance within ±20% of initial value. No disconnection or short circuit. The appearance shall not break.	<p>After 100 cycles of following condition.</p> <table border="1"> <thead> <tr> <th>Step</th> <th>Temperature (°C)</th> <th>Times (min.)</th> </tr> </thead> <tbody> <tr> <td>1</td> <td>-40±3°C</td> <td>30</td> </tr> <tr> <td>2</td> <td>Room Temperature</td> <td>Within 3</td> </tr> <tr> <td>3</td> <td>125±2°C</td> <td>30</td> </tr> <tr> <td>4</td> <td>Room Temperature</td> <td>Within 3</td> </tr> </tbody> </table>	Step	Temperature (°C)	Times (min.)	1	-40±3°C	30	2	Room Temperature	Within 3	3	125±2°C	30	4	Room Temperature	Within 3
Step	Temperature (°C)	Times (min.)															
1	-40±3°C	30															
2	Room Temperature	Within 3															
3	125±2°C	30															
4	Room Temperature	Within 3															
Vibration Test	Inductance within ±10% of initial value and appearance shall not break.	After vibration for 1hour, In each of three orientations at sweep vibration (10~55~10Hz) with 1.5mm P-P Amplitudes.															
Terminal strength	The terminal electrode and the ferrite must not be damaged	<p>Solder a chip to test substrate, and then laterally apply a load 5N in the arrow direction, Duration :5s</p> 															
Drop Test	Inductance within ±20% of initial value. The appearance shall not break.	Drop 3 times on a concrete floor from a height of 75cm by inimum packing															