



MORE[®] | 茂昌电子
CHANCE

CUSTOMER : STD
PRODUCTS : SHIELDED SMD Power Inductor
PART NO : MCSI2E Series
CUST P/ NO :
DATE : 2021.11.30
SALES DEP :
E-MAIL :

VERSION : REV.A
CHANGE PROJECT : -
BEFORE : -
AFTER : -
CHANGE DATE : 2024.7.18
CUSTOMER SIGNATURE : -

APPROVAL BY :	CHECK BY :	DRAWN BY :
<i>Honey Wei</i>	<i>Leo Wang</i>	<i>May Gao</i>



MORE[®]
CHANCE

茂昌电子

Suzhou, Wuzhong District, Taihu East Road No.9, Wuluo science and Technology Park, 4th floor, 401/408 Room
Specifications subject to change without notice. Please confirm according to our company for latest information.

TEL : 0512-6856-2977
TEL : 0755-2738-9457

MCS12E Series



- SHIELDED SMD POWER INDUCTOR
- Operating Temperature up to $-40\text{ }^{\circ}\text{C} \sim 125\text{ }^{\circ}\text{C}$
- High Current up to 165 A
- Low DCR down to 0.15mOhms
- Environmental Lead free
- Environmental RoHS2.0 compliant
- Environmental halogen free
- Storage Temperature : $-40\text{ }^{\circ}\text{C} \sim +85\text{ }^{\circ}\text{C}$
- Packaging 13"Reel ,Plastic tape:24.0mm wide

FEATURES

- Ferrite based with lower core loss
- Ferrite High Bs material.
- Accurate&low DCR design
- Ultra high current capacity.
- Use 1.5 turn loop design for higher Inductance.

Applications

- Multi-phase and Vcore regulators.
- Server and desktop VRMs and EVRDs.
- Data networking and storage systems.
- Graphics cards and battery power systems.
- Buck Converter,VRMs.

PRODUCT IDENTIFICATION

MC SI2E 09609 Z R10 L R17
 ① ② ③ ④ ⑤ ⑥ ⑦

- ① Brand & Product classification
- ② Product Series NO.(SI2E : SMD Power Inductors.)
- ③ External Dimensions.(09609 : L:9.0 × W:6.0 × H:9.0) [mm]
- ④ Separator code.
- ⑤ Nominal Inductance

Example	Nominal Value
R22	0.22uH
1R0	1.0uH
100	10uH
101	100uH
70NH	70nH

- ⑥ Inductance Tolerance.(L: $\pm 15\%$; M: $\pm 20\%$; N: $\pm 30\%$)
- ⑦ Nominal DC Resistance.(R17 : 0.17m Ω)

Mechanical & Dimensions (Unit: mm)

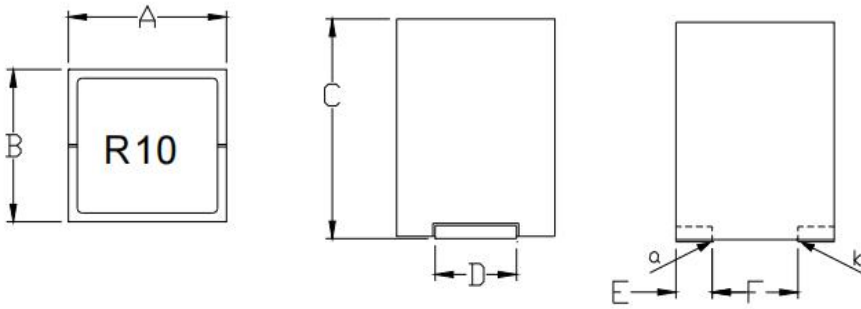

Code	Dimensions
A	7.0 Max
B	6.7 Max
C	11.1 Max
D	3.7 ± 0.2
E	1.8 ± 0.2
F	2.8 ± 0.3

Recommend Land Pattern Dimensions (Unit: mm)

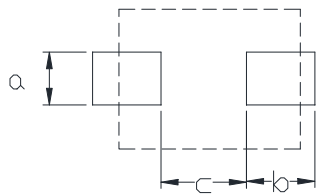

Code	Dimensions
a	4.2 Ref
b	2.3 Ref
c	2.3 Ref

Electrical Characteristics

Part Number	Inductance ¹ (nH)	DCR ² (mΩ)	I-sat ^{3.1} (Amps)Typ	I-sat ^{3.2} (Amps)Typ	I-rms ⁴ (Amps)Typs
MCSI2E0711Z70NLR145	70±15%	0.145±10%	134.0	114.0	76.0
MCSI2E0711ZR10LR145	100±15%	0.145±10%	93.0	79.0	76.0
MCSI2E0711ZR12LR145	120±15%	0.145±10%	76.0	65.0	76.0
MCSI2E0711ZR15LR145	150±15%	0.145±10%	60.0	51.0	76.0

Note:
 1. Inductance is measured at 100 KHz and 1.0 Vrms at 25°C
 2. The nominal DCR is measured at 20°C ambient temperature.
 3.1 The I-sat that will cause initial inductance value approximately 20% rolloff at 25°C
 3.2 The I-sat that will cause initial inductance value approximately 20% rolloff at 125°C
 4. The I-rms that will cause temperature rise approximate 40°C without core loss.

Mechanical & Dimensions (Unit: mm)

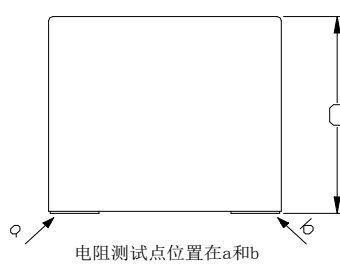
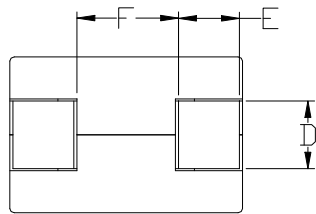
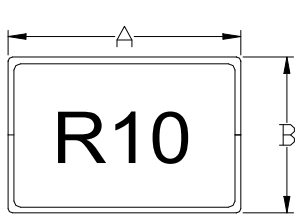

Code	Dimensions
A	8.8 ± 0.18
B	4.7 ± 0.28
C	9.3 ± 0.18
D	2.40 ± 0.20
E	2.50 ± 0.20

Recommend Land Pattern Dimensions (Unit: mm)

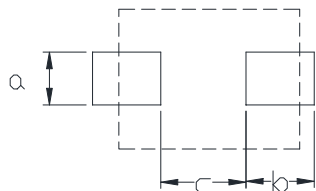

Code	Dimensions
a	2.9 Ref
b	2.8 Ref
c	3.7 Ref

Electrical Characteristics

Part Number	Inductance ¹ (nH)	DCR ² (mΩ)	I-sat ^{3,1} (Amps)Typ	I-rms ⁴ (Amps)Typs		
MCSI2E09509ZR15LR125	150±15%	0.125±8%	58.0	63.0		

Note:
 1. Inductance is measured at 100 KHz and 1.0 Vrms at 25°C
 2. The nominal DCR is measured at 20°C ambient temperature.
 3.1 The I-sat that will cause initial inductance value approximately 20% rolloff at 25°C
 3.2 The I-sat that will cause initial inductance value approximately 20% rolloff at 125°C
 4. The I-rms that will cause temperature rise approximate 40°C without core loss.

Mechanical & Dimensions

(Unit: mm)

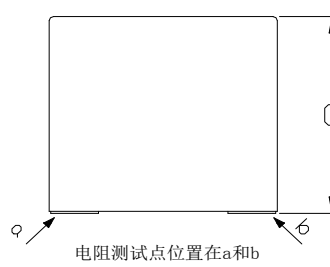
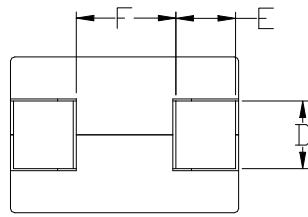
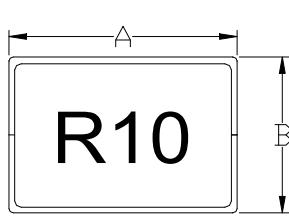

Code	Dimensions
A	9.6 Max
B	6.4 Max
C	9.15 Max
D	2.6±0.2
E	2.5±0.3
F	4.0±0.5

Recommend Land Pattern Dimensions

(Unit: mm)

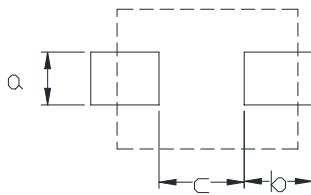

Code	Dimensions
a	2.9 Ref
b	2.8 Ref
c	3.7 Ref

Electrical Characteristics

Part Number	Inductance ¹ (nH)	DCR ² (mΩ)	I-sat ^{3.1} (Amps)Max	I-sat ^{3.2} (Amps)Max	I-rms ⁴ (Amps)Typs
MCSI2E09609ZR10LR17	100±15%	0.17±10%	100.0	90.0	66.0
MCSI2E09609ZR12LR17	120±15%	0.17±10%	94.0	75.0	66.0
MCSI2E09609ZR15LR17	150±15%	0.17±10%	75.0	60.0	66.0
MCSI2E09609ZR30LR17	300±15%	0.17±10%	33.0	29.0	66.0

Note:

- Inductance is measured at 100 KHz and 1.0 Vrms at 25°C
- The nominal DCR is measured at 20°C ambient temperature.
- 1The I-sat that will cause initial inductance value approximately 20% rolloff at 25°C
- 2The I-sat that will cause initial inductance value approximately 20% rolloff at 125°C
- 4.The I-rms that will cause temperature rise approximate 40°C without core loss.

Mechanical & Dimensions

(Unit: mm)

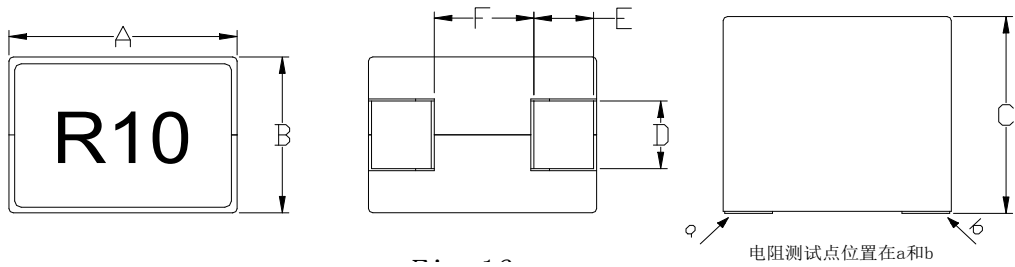

Code	Dimensions
A	9.6 Max
B	6.6 Max
C	10.0 Max
D	3.2±0.2
E	2.7±0.3
F	3.4±0.5

Recommend Land Pattern Dimensions

(Unit: mm)

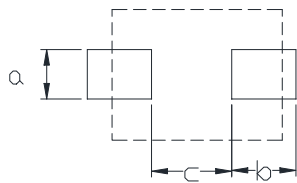

Code	Dimensions
a	3.5 Ref
b	3.0 Ref
c	3.0 Ref

Electrical Characteristics

Part Number	Inductance ¹ (nH)	DCR ² (mΩ)	DCR ² (mΩ)	I-sat ^{3.1} (Amps)Max	I-sat ^{3.2} (Amps)Max	I-rms ⁴ (Amps)Typs
MCSI2E09610Z70NHLR12	70±15%	0.10 Typ	0.12 Max	145.0	126.0	84.0
MCSI2E09610ZR10LR12	100±15%	0.10 Typ	0.12 Max	108.0	90.0	84.0
MCSI2E09610ZR12LR12	120±15%	0.10 Typ	0.12 Max	85.0	72.0	84.0
MCSI2E09610ZR15LR12	150±15%	0.10 Typ	0.12 Max	67.0	58.0	84.0
MCSI2E09610ZR18LR12	180±15%	0.10 Typ	0.12 Max	56.0	49.0	84.0
MCSI2E09610ZR22LR12	220±15%	0.10 Typ	0.12 Max	46.0	40.0	84.0
MCSI2E09610ZR28LR12	280±15%	0.10 Typ	0.12 Max	36.0	31.0	84.0

Note:

- Inductance is measured at 100 KHz and 1.0 Vrms at 25°C
- The nominal DCR is measured at 20°C ambient temperature.
- 1The I-sat that will cause initial inductance value approximately 20% rolloff at 25°C
- 2The I-sat that will cause initial inductance value approximately 20% rolloff at 125°C
- 4.The I-rms that will cause temperature rise approximate 40°C without core loss.

Mechanical & Dimensions

(Unit: mm)

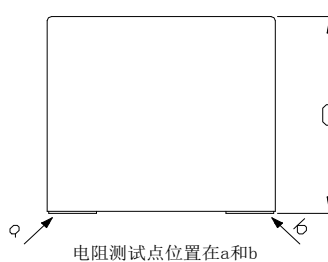
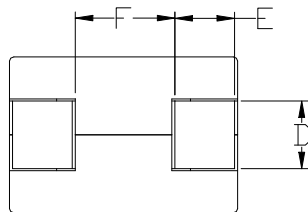
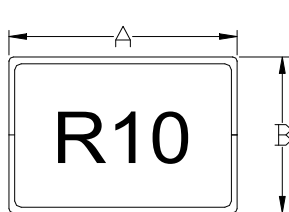

Code	Dimensions
A	9.6 Max
B	6.6 Max
C	12.2 Max
D	2.6±0.3
E	2.6±0.3
F	3.8±0.5

Recommend Land Pattern Dimensions

(Unit: mm)

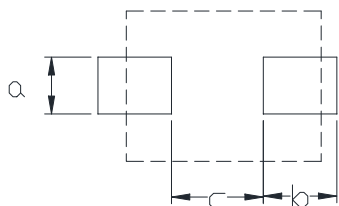

Code	Dimensions
a	2.9 Ref
b	2.9 Ref
c	3.5 Ref

Electrical Characteristics

Part Number	Inductance ¹ (nH)	DCR ² (mΩ)	I-sat ^{3.1} (Amps)Max	I-sat ^{3.2} (Amps)Max	I-rms ⁴ (Amps)Typs
MCSI2E09612ZR30LR175	300±15%	0.175±10%	44.0	37.0	65.0
MCSI2E09612ZR47LR175	470±15%	0.175±10%	27.0	23.0	65.0

Note:
 1. Inductance is measured at 100 KHz and 1.0 Vrms at 25°C
 2. The nominal DCR is measured at 20°C ambient temperature.
 3.1 The I-sat that will cause initial inductance value approximately 20% rolloff at 25°C
 3.2 The I-sat that will cause initial inductance value approximately 20% rolloff at 100°C
 4. The I-rms that will cause temperature rise approximate 40°C without core loss.

Mechanical & Dimensions

(Unit: mm)

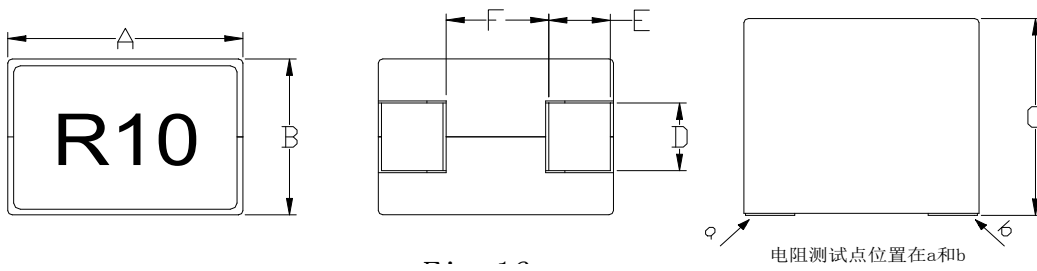

Code	Dimensions
A	10.0 Max
B	6.0 Max
C	12.0 Max
D	2.45±0.3
E	2.95±0.3
F	3.5±0.5

Recommend Land Pattern Dimensions

(Unit: mm)

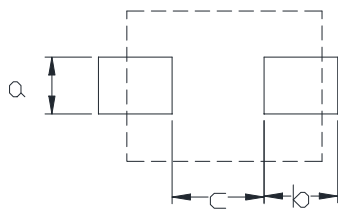

Code	Dimensions
a	3.8 Ref
b	3.25 Ref
c	3.2 Ref

Electrical Characteristics

Part Number	Inductance ¹ (nH)	DCR ² (mΩ)	I-sat ³ (Amps)Max	I-rms ⁴ (Amps)Typs		
MCSI2E10612ZR07LR125	70±15%	0.125±10%	175, ≥49nH	70.0		
MCSI2E10612ZR10LR125	100±15%	0.125±10%	125, ≥70nH	70.0		
MCSI2E10612ZR12LR125	120±15%	0.125±10%	105, ≥84nH	70.0		
MCSI2E10612ZR15LR125	150±15%	0.125±10%	83, ≥105nH	70.0		
MCSI2E10612ZR22LR125	220±15%	0.125±10%	52, ≥154nH	70.0		

- Note:
- Inductance is measured at 100 KHz and 1.0 Vrms at 25°C
 - The nominal DCR is measured at 20°C ambient temperature.
 - The I-sat that will cause rolloff nominal inductance value at 25°C
 - The I-rms that will cause temperature rise approximate 40°C without core loss.

Mechanical & Dimensions (Unit: mm)

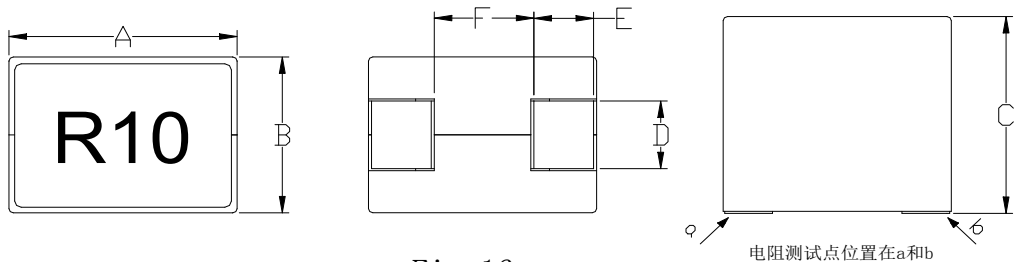

Code	Dimensions
A	10.7 Max
B	7.5 Max
C	9.5 Max
D	2.8±0.3
E	2.8±0.3
F	4.6±0.5

Recommend Land Pattern Dimensions (Unit: mm)

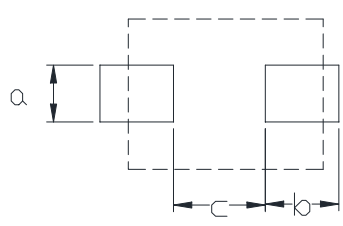

Code	Dimensions
a	3.1 Ref
b	3.1 Ref
c	4.3 Ref

Electrical Characteristics

Part Number	Inductance ¹ (nH)	DCR ² (mΩ)	I-sat ^{3.1} (Amps)Max	I-sat ^{3.2} (Amps)Max	I-sat ^{3.3} (Amps)Max	I-rms ⁴ (Amps)Typs
MCSI2E10795ZR30LR23	300±15%	0.23±10%	50.0	41.0	37.0	61.0

Note:

1. Inductance is measured at 100 KHz and 1.0 Vrms at 25°C
2. The nominal DCR is measured at 20°C ambient temperature.
- 3.1 The I-sat that will cause initial inductance value approximately 20% rolloff at 25°C
- 3.2 The I-sat that will cause initial inductance value approximately 20% rolloff at 100°C
- 3.3 The I-sat that will cause initial inductance value approximately 20% rolloff at 125°C
4. The I-rms that will cause temperature rise approximate 40°C without core loss.

Mechanical & Dimensions (Unit: mm)

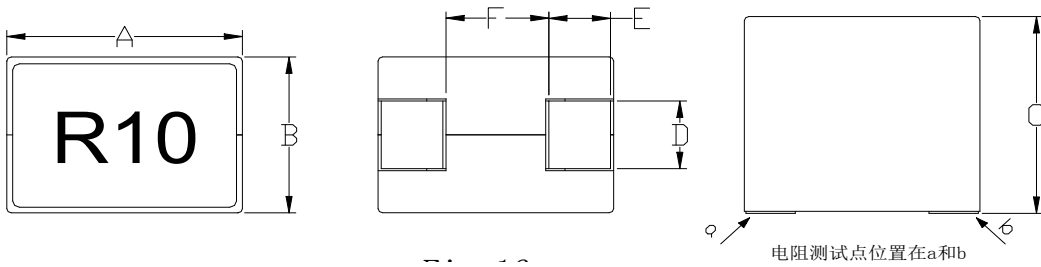

Code	Dimensions
A	10.0 Max
B	7.0 Max
C	10.0 Max
D	2.2±0.3
E	2.3±0.3
F	4.1±0.5

Recommend Land Pattern Dimensions (Unit: mm)

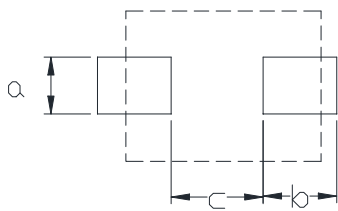

Code	Dimensions
a	2.5 Ref
b	2.6 Ref
c	3.8 Ref

Electrical Characteristics

Part Number	Inductance ¹ (nH)	DCR ² (mΩ)	I-sat ³ (Amps)Max	I-rms ⁴ (Amps)Typs		
MCSI2E10710Z70NH1R17	70±15%	0.17±10%	165.0	68.0		
MCSI2E10710ZR10LR17	100±15%	0.17±10%	135.0	68.0		
MCSI2E10710ZR12LR17	120±15%	0.17±10%	107.0	68.0		
MCSI2E10710ZR15LR17	150±15%	0.17±10%	92.0	68.0		
MCSI2E10710ZR20LR17	200±15%	0.17±10%	68.0	68.0		
MCSI2E10710ZR22LR17	220±15%	0.17±10%	62.0	68.0		
MCSI2E10710ZR33LR17	330±15%	0.17±10%	37.0	68.0		

Note:

- Inductance is measured at 100 KHz and 1.0 Vrms at 25°C
- The nominal DCR is measured at 20°C ambient temperature.
- The I-sat that will cause initial inductance value approximately 20% rolloff at 25°C
- The I-rms that will cause temperature rise approximate 40°C without core loss.

Mechanical & Dimensions

(Unit: mm)

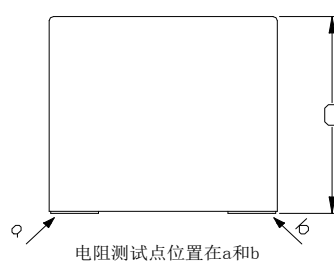
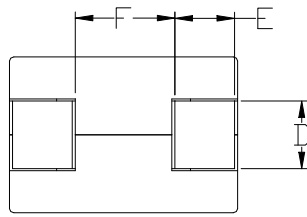
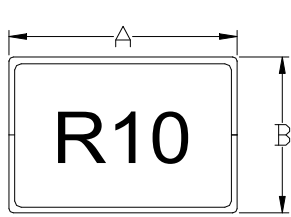

Code	Dimensions
A	10.7 Max
B	7.6 Max
C	12.2 Max
D	3.1±0.3
E	2.8±0.3
F	4.4±0.5

Recommend Land Pattern Dimensions

(Unit: mm)

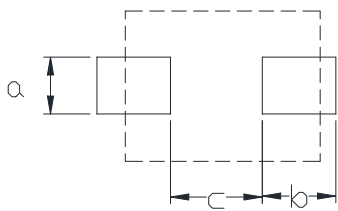

Code	Dimensions
a	3.4 Ref
b	3.1 Ref
c	4.1 Ref

Electrical Characteristics

Part Number	Inductance ¹ (nH)	DCR ² (mΩ)	I-sat ^{3.1} (Amps)Max	I-sat ^{3.2} (Amps)Max	I-rms ⁴ (Amps)Typs
MCSI2E10712ZR27LR15	270±15%	0.15±10%	60.0	51.0	75.0
MCSI2E10712ZR20LR15	200±15%	0.15±10%	95.0	70.0	75.0

Note:

1. Inductance is measured at 100 KHz and 1.0 Vrms at 25°C
2. The nominal DCR is measured at 20°C ambient temperature.
- 3.1 The I-sat that will cause initial inductance value approximately 20% rolloff at 25°C
- 3.2 The I-sat that will cause initial inductance value approximately 20% rolloff at 100°C
4. The I-rms that will cause temperature rise approximate 40°C without core loss.

Packaging

Reel Dimension:

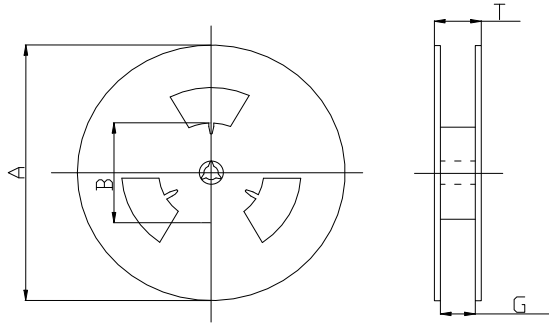

P/N	Type	A(mm)	B(mm)	G(mm)	T(mm)	Chip/Reel
MCSI2E0711(R145)	13" x 24mm	330	100	24.5	28.7	400
MCSI2E09509(R125)	13" x 24mm	330	100	24.5	28.7	500
MCSI2E09609(R17)	13" x 24mm	330	100	24.5	28.7	500
MCSI2E09610(R12)	13" x 24mm	330	100	24.5	28.7	400
MCSI2E09612(R175)	13" x 24mm	330	100	24.5	28.7	250
MCSI2E10612(R125)	13" x 24mm	330	100	24.5	28.7	400
MCSI2E10795(R23)	13" x 24mm	330	100	24.5	28.7	350
MCSI2E10710(R17)	13" x 24mm	330	100	24.5	28.7	500
MCSI2E10712(R15)	13" x 24mm	330	100	24.5	28.7	300

Packaging

Tape Dimension:

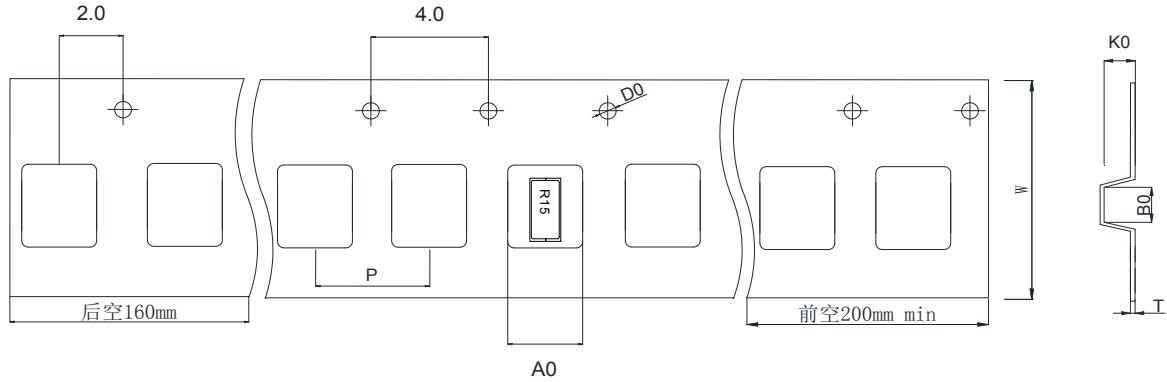

P/N	Ao	Bo	Ko	P	W						
MCSI2E0711(R145)	6.8±0.1	9.8±0.1	9.8±0.1	12.0±0.1	24.0±0.3						
MCSI2E09509(R125)	6.8±0.1	9.8±0.1	9.8±0.1	12.0±0.1	24.0±0.3						
MCSI2E09609(R17)	6.8±0.1	9.8±0.1	9.8±0.1	12.0±0.1	24.0±0.3						
MCSI2E09610(R12)	6.6±0.1	10.0±0.1	10.3±0.1	12.0±0.1	24.0±0.3						
MCSI2E09612(R175)	6.7±0.1	10.1±0.1	12.4±0.1	16.0±0.1	24.0±0.3						
MCSI2E10612(R125)	6.4±0.1	10.4±0.1	12.5±0.1	12.0±0.1	24.0±0.3						
MCSI2E10795(R23)	7.7±0.1	11.1±0.1	10.2±0.1	16.0±0.1	24.0±0.3						
MCSI2E10710(R17)	7.0±0.1	10.0±0.1	10.0±0.1	12.0±0.1	24.0±0.3						
MCSI2E10712(R15)	7.7±0.1	11.1±0.1	12.4±0.1	16.0±0.1	24.0±0.3						

Packaging

Tearing Off Force:

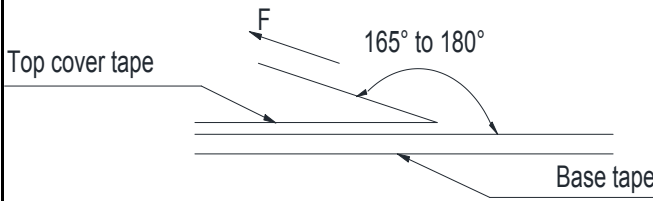

The force tearing off cobe tape is 10 to 130 g.f			
in the arrow direction under the following conditions			
Room Temp (°C)	Room Humidity (%)	Room atrn (hPa)	Teaming Speed (mm/min)
5~35	45~85	860~1060	300

※Storage Conditions

1. Temperature and humidity conditions:
-40°C ~ +85°C and 70% RH.
2. Recommended products should be used within 6 months form the time of delivery.
3. The packaging material should be kept where no chlorine or sulfur exists in the air.

※Transportation

1. Products should be handled with care to avoid damage or contamination from perspiration and skin oils.
2. The use of tweezers or vacuum pick up is strongly recommended for individual components.
3. Bulk handling should ensure that abrasion and mechanical shock are minimized.

Recommended Soldering Conditions

Figure 1. Re-flow Soldering

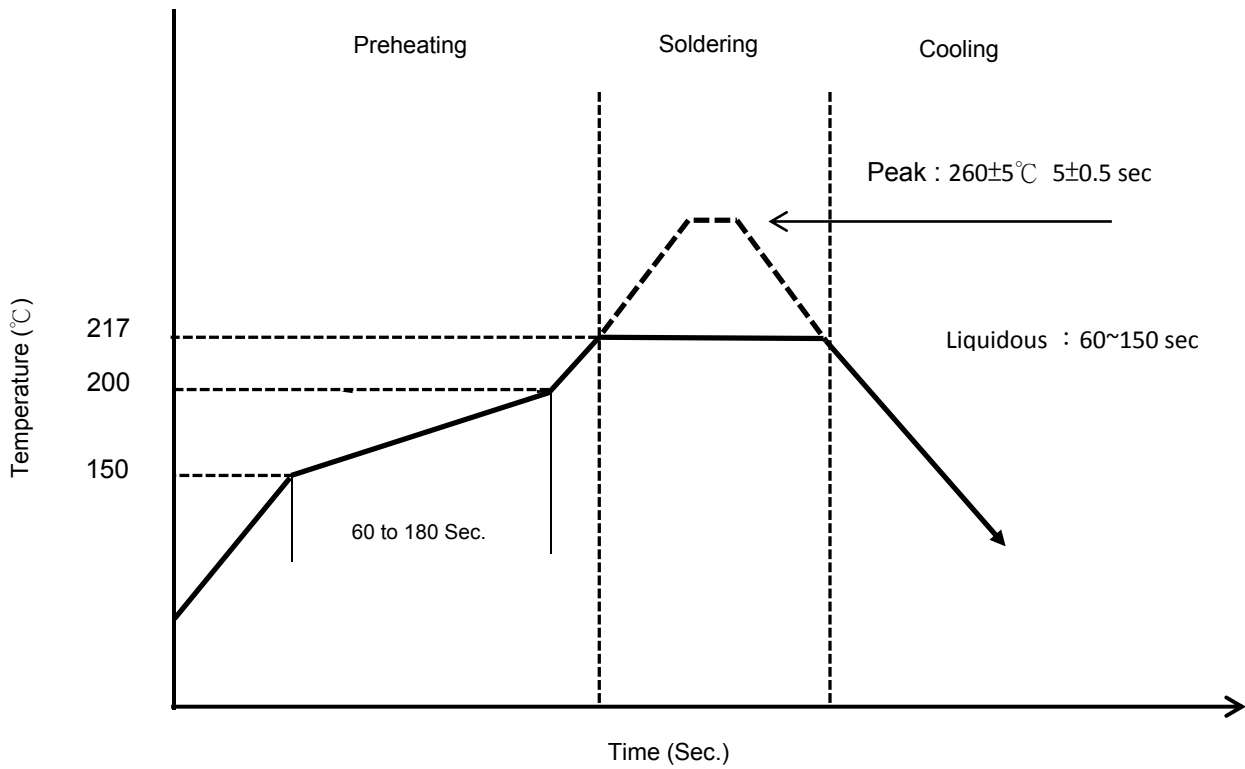
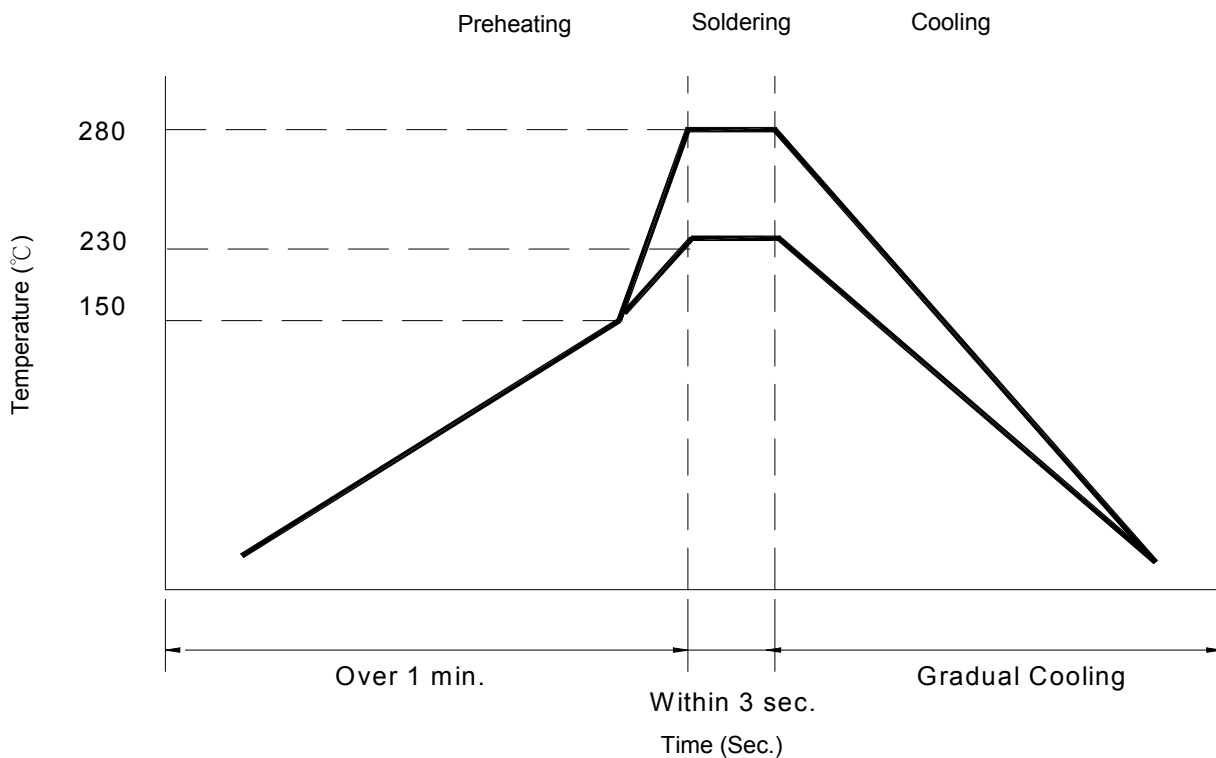
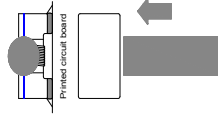

Figure 2. Hand Soldering



Reliability and Testing Conditions																	
Item	Specification	Conditions															
Operating temperature range	-40°C ~ +125°C (Including self-temperature rise)																
Storage temperature and humidity range	-40°C ~ +85°C , 70% RH Max																
Solderability	More than 90% of the terminal electrode should be covered with solder.	<ul style="list-style-type: none"> - Preheat: 150 °C , 60 sec - Solder: Sn96.5%-Ag3%-Cu0.5% - Temperature: 245±5°C - Flux for lead free: Rosin 9.5% - Dip time: 4±1 sec - Depth: completely cover the termination 															
Resistance to Soldering Heat	Inductance within ±20% of initial value. No disconnection or short circuit. The appearance shall not break.	<ul style="list-style-type: none"> - Solder technique simulation: SMD - Temperature (°C): 260 ± 5 (solder temp) - Time (s): 10 ± 1 - Temperature ramp / immersion and emersion rate: 25 mm/s ± 6 mm/s - Number of heat cycles: 1 															
Resistance to High Temperature	Inductance within ±20% of initial value. No disconnection or short circuit. The appearance shall not break.	500 hrs. at 125°C±5°C Unpowered. Measurement at 24±4 hours after test conclusion.															
Resistance to Low Temperature	Inductance within ±20% of initial value. No disconnection or short circuit. The appearance shall not break.	500 hrs. at -40°C±5°C. Unpowered. Measurement at 24±4 hours after test conclusion.															
Resistance to Humidity	Inductance within ±20% of initial value. No disconnection or short circuit. The appearance shall not break.	After 500 hours in 40±2°C and 90 to 95% humidity , and 2 hour drying under normal condition.															
Thermal shock	Inductance within ±20% of initial value. No disconnection or short circuit. The appearance shall not break.	<p>After 100 cycles of following condition.</p> <table border="1" style="margin-left: auto; margin-right: auto;"> <thead> <tr> <th>Step</th> <th>Temperature (°C)</th> <th>Times (min.)</th> </tr> </thead> <tbody> <tr> <td>1</td> <td>-40±5°C</td> <td>30</td> </tr> <tr> <td>2</td> <td>Room Temperature</td> <td>Within 3</td> </tr> <tr> <td>3</td> <td>125±5°C</td> <td>30</td> </tr> <tr> <td>4</td> <td>Room Temperature</td> <td>Within 3</td> </tr> </tbody> </table>	Step	Temperature (°C)	Times (min.)	1	-40±5°C	30	2	Room Temperature	Within 3	3	125±5°C	30	4	Room Temperature	Within 3
Step	Temperature (°C)	Times (min.)															
1	-40±5°C	30															
2	Room Temperature	Within 3															
3	125±5°C	30															
4	Room Temperature	Within 3															
Vibration Test	Inductance within ±10% of initial value and appearance shall not break.	After vibration for 1hour, In each of three orientations at sweep vibration (10~55~10Hz) with 1.52mm P-P Amplitudes.															
Terminal strength	The terminal electrode and the ferrite must not be damaged	<p>Solder a chip to test substrate, and then laterally apply a load 10N in the arrow direction, Duration :5s</p> 															
Drop Test	Inductance within ±20% of initial value. The appearance shall not break.	Drop 3 times on a concrete floor from a height of 75cm by inimum packing															